

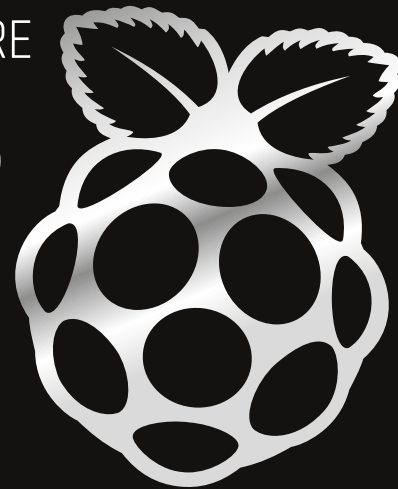

BUY IN PRINT WORLDWIDE [MAGPI.CC/STORE](http://MAGPI.CC/STORE)

# The *MagPi*



Issue 75 | November 2018 | [magpi.cc](http://magpi.cc)

The official Raspberry Pi magazine

# 75

## GREATEST RASPBERRY PI PROJECTS

Make something amazing with  
these inspirational builds



## CanaKit Raspberry Pi 3 Ultimate Starter Kit

Model B | 1 GB RAM | 1.2 GHz | Quad-Core CPU



- > Learn to Code
- > Explore Computing
- > Get started with Electronics

### KIT INCLUDES RASPBERRY PI 3 AND ...

<p><b>PREMIUM CASE &amp; HEAT SINKS</b></p>	<p><b>2.5A POWER ADAPTER</b></p>	<p><b>32 GB CLASS 10 MICROSD CARD</b></p> <p>PRE-LOADED WITH OPERATING SYSTEM</p>	<p><b>USB MICROSD CARD READER</b></p>	<p><b>PREMIUM HDMI CABLE</b></p>	<p><b>QUICK-START GUIDE</b></p>
<p><b>GPIO TO BREADBOARD INTERFACE BOARD</b></p>	<p><b>RIBBON CABLE</b></p>	<p><b>FULL-SIZE BREADBOARD</b></p>	<p><b>JUMPERS</b></p> <p>MALE TO MALE &amp; MALE TO FEMALE</p>	<p><b>LEDs</b></p>	<p><b>RESISTORS &amp; PUSH-BUTTONS</b></p>

Available for worldwide shipping at:

**WWW.CANAKIT.COM**

**Raspberry Pi Zero W**  
Now available at CanaKit!



# WELCOME

## to issue 75

**T**hank you so much for helping us get all the way to issue 75. We often say it, but *The MagPi* is a community magazine. Many articles are written by the Raspberry Pi community; all our amazing projects are built by the community, and every penny we make is ploughed back into ensuring The Raspberry Pi Foundation can train the next generation of Raspberry Pi makers.

We truly couldn't make this magazine without the Raspberry Pi community. You are stars, each and every one of you.

In honour of this massive milestone, we have been working with the community to choose the 75 Greatest Raspberry Pi projects (page 14).

It's an absolute honour to edit *The MagPi*, but we really couldn't do it without our readers. So let's all raise a glass to issue 75, and look forward to many more issues to come.

**Lucy Hattersley** Editor



**EDITOR** **Lucy Hattersley**

Editor of *The MagPi*. Lucy codes, crafts, and creates wonky robots. She speaks French (badly) and mangles the piano. One day she'll get that pet dog.

[magpi.cc](http://magpi.cc)





# Contents

▶ Issue 75 ▶ November 2018

## Cover Feature

14 The 75 Greatest Projects

## Regulars

- 06 The world of Pi
- 92 Your letters
- 97 Next month
- 98 Final word

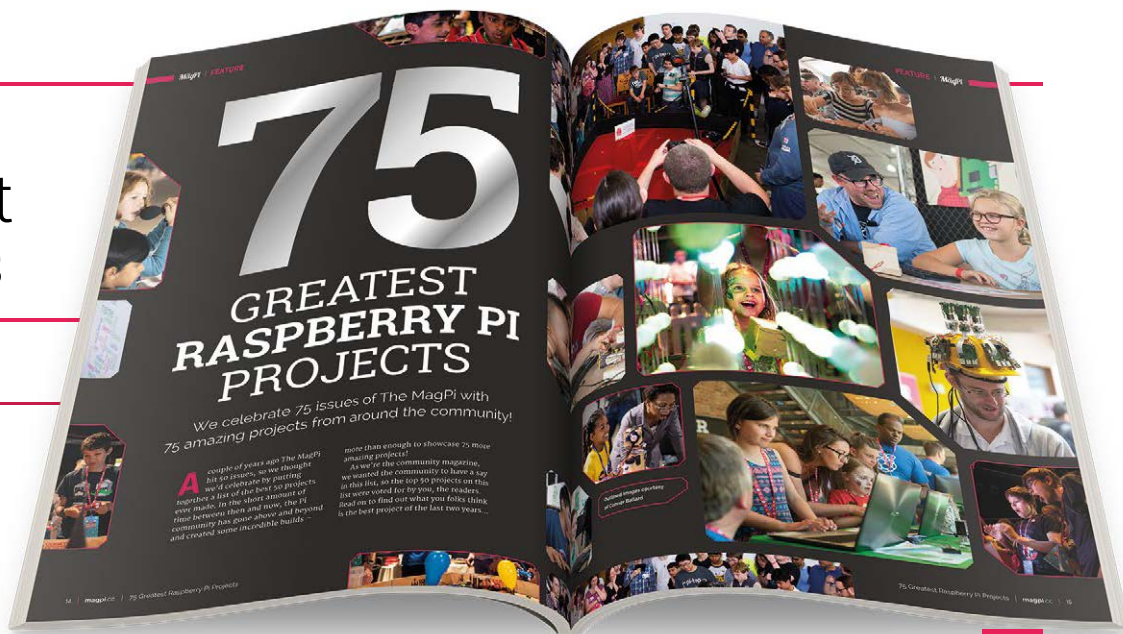

## Project Showcases

- 08 The 4D Arcade
- 12 Knitting Network Printer



4D Arcade



Knitting Network Printer

**DISCLAIMER:** Some of the tools and techniques shown in The MagPi magazine are dangerous unless used with skill, experience, and appropriate personal protection equipment. While we attempt to guide the reader, ultimately you are responsible for your own safety and understanding the limits of yourself and your equipment. Children should be supervised. Raspberry Pi (Trading) Ltd does not accept responsibility for any injuries, damage to equipment, or costs incurred from projects, tutorials or suggestions in The MagPi magazine. Laws and regulations covering many of the topics in The MagPi magazine are different between countries, and are always subject to change. You are responsible for understanding the requirements in your jurisdiction and ensuring that you comply with them. Some manufacturers place limits on the use of their hardware which some projects or suggestions in The MagPi magazine may go beyond. It is your responsibility to understand the manufacturer's limits.



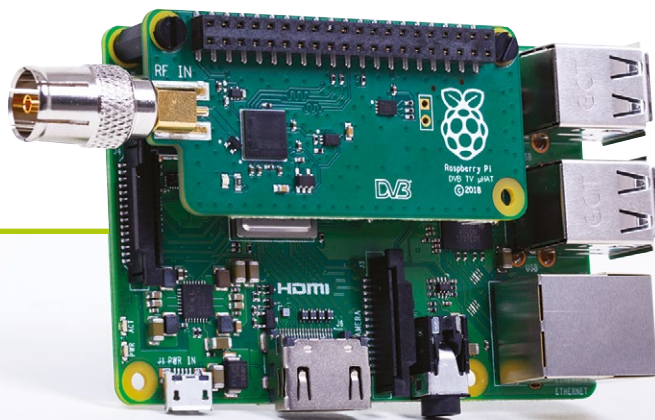

42

Install Raspberry Pi TV HAT

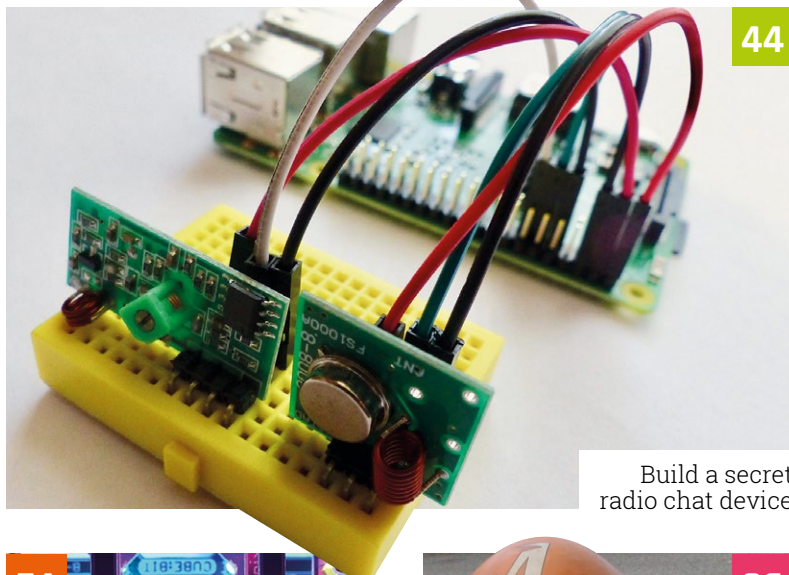

44

Build a secret radio chat device

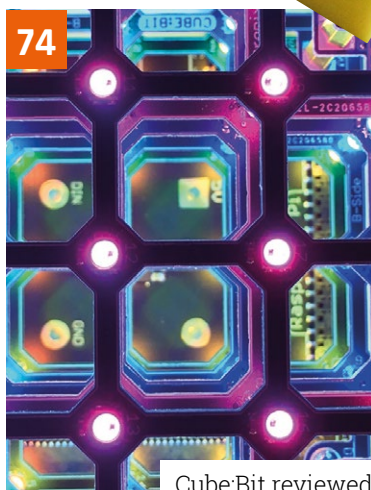

74

Cube:Bit reviewed

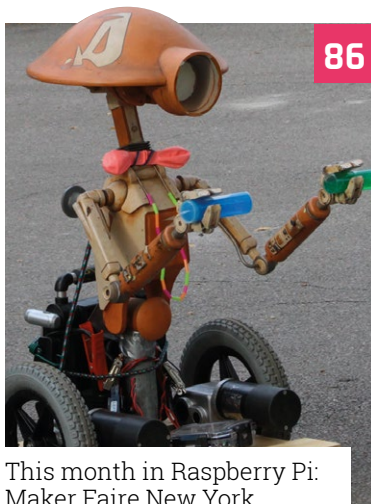

86

This month in Raspberry Pi: Maker Faire New York

**Tutorials**

- 42 Install Raspberry Pi TV HAT
- 44 Build a secret radio chat device
- 48 The Matrix part 3
- 54 Code Space Invaders part 2
- 62 Make games in C part 11

**The Big Feature**

**66 Camera Projects**

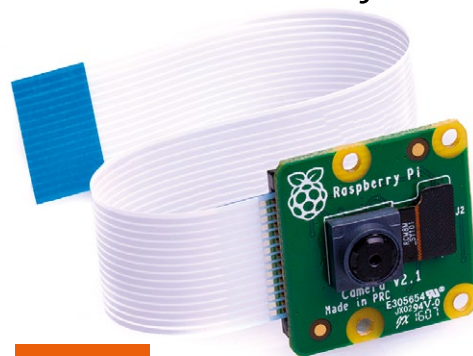

**Reviews**

- 74 Cube:Bit
- 76 HiFiBerry DAC+ DSP
- 78 Top 10 starter kits
- 80 Minecraft resources

**Community**

- 84 Interview
- 86 This month in Raspberry Pi: Maker Faire New York
- 90 Events



**WIN One of Two**

Picade retro gaming consoles!



95

In association with

**PIMORONI**

# Coollest Projects 2019

## dates announced



A showcase for young innovators, Coollest Projects is simply inspirational. **Rosie Hattersley** reports

**B**ack in 2012, when Raspberry Pi was merely a great new idea garnering lots of positive praise, another excellent innovation aimed at inspiring young creators was also in its infancy.

Coollest Projects ([coolestprojects.org](http://coolestprojects.org)) began in Ireland as a science fair and forum for like-minded inventors to meet and show off their ideas. Founded by CoderDojo volunteers Noel King and Ben Chapman, the event has gone from strength to strength, with thousands of young scientists and technologists attending Dublin's annual Coollest Projects showcase each year.

▣ The event is not just about the creativity, innovation, and sheer effort that everyone puts in, but the sense of community ▣

This year, Coollest Projects came under the wing of The Raspberry Pi Foundation, with events in Ireland, the UK, and North America.

These locations will be hosting Coollest Projects fairs again in 2019, according to The Raspberry Pi Foundation CEO Philip Colligan.



▲ During Coollest Projects, kids get to show off the amazing projects that they've built





▲ The Raspberry Pi Foundation CEO Philip Colligan taking lessons from his son, Dylan

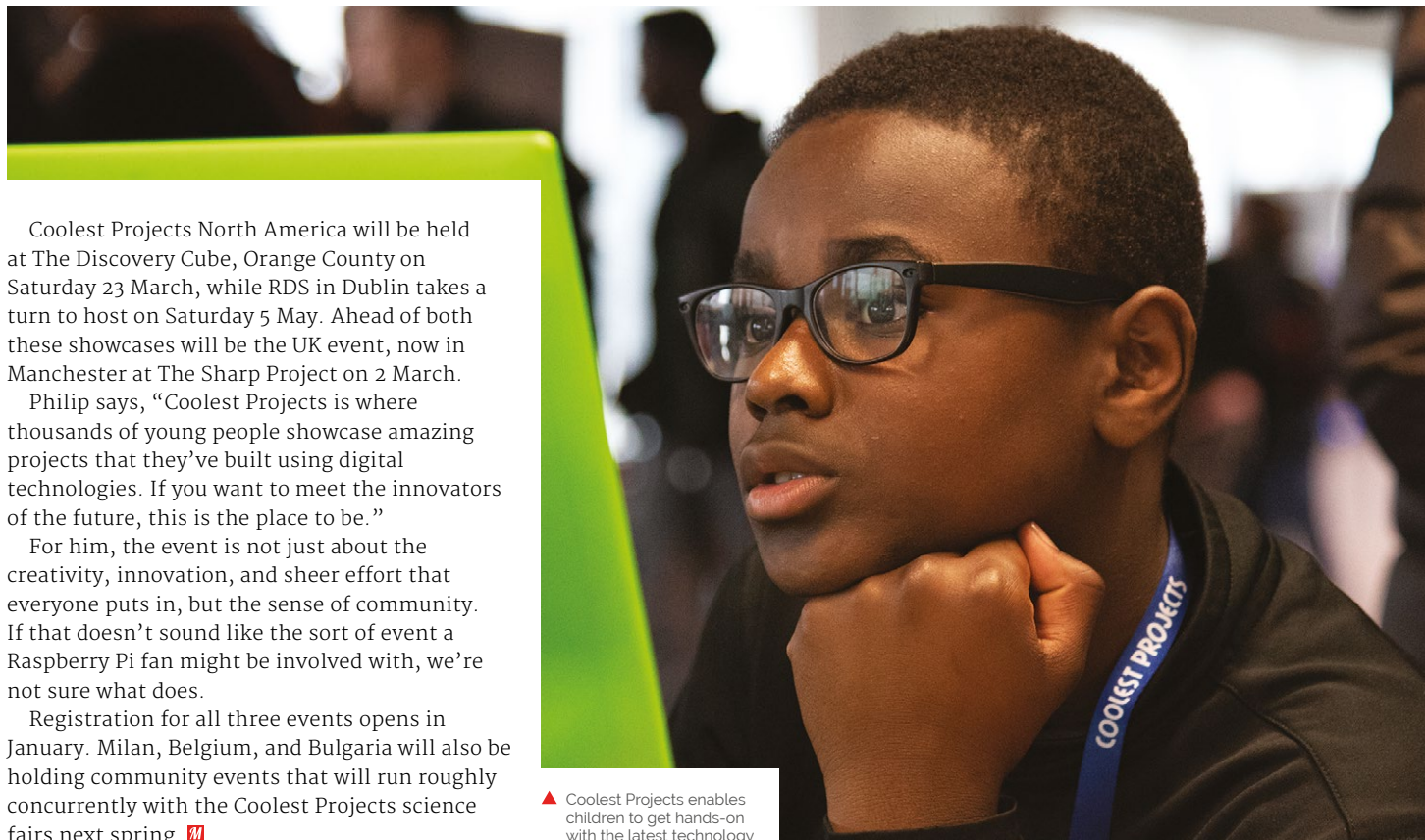

Coollest Projects North America will be held at The Discovery Cube, Orange County on Saturday 23 March, while RDS in Dublin takes a turn to host on Saturday 5 May. Ahead of both these showcases will be the UK event, now in Manchester at The Sharp Project on 2 March.

Philip says, “Coolest Projects is where thousands of young people showcase amazing projects that they’ve built using digital technologies. If you want to meet the innovators of the future, this is the place to be.”

For him, the event is not just about the creativity, innovation, and sheer effort that everyone puts in, but the sense of community. If that doesn’t sound like the sort of event a Raspberry Pi fan might be involved with, we’re not sure what does.

Registration for all three events opens in January. Milan, Belgium, and Bulgaria will also be holding community events that will run roughly concurrently with the Coolest Projects science fairs next spring. [📅](#)

▲ Coolest Projects enables children to get hands-on with the latest technology



# 4D Arcade Machine: Can't Drive This

A Raspberry Pi-powered arcade display with hidden interactive controls won over the crowds at Gamescom.

**Rosie Hattersley** and **Rob Zwetsloot** got the inside scoop



## Pixel Maniacs

Pixel Maniacs is a Nuremberg-based games maker that started out making mobile apps. These days it specialises in games for PC, Xbox One, PlayStation, and Nintendo Switch. You Can't Drive This is its first foray into gaming with a Raspberry Pi.

[pixel-maniacs.com](http://pixel-maniacs.com)

If you're going to add a little something extra to wow the crowd at the Gamescom video games trade fair, a Raspberry Pi is a surefire way of getting you noticed. And that's the way Pixel Maniacs went about it.

The Nuremberg-based games developer retrofitted an arcade machine with a Raspberry Pi to showcase its intentionally silly Can't Drive This precarious driving game ([magpi.cc/TphZao](http://magpi.cc/TphZao)) at Gamescom.

Complete with wrecking balls, explosions, an inconvenient number of walls, and the jeopardy of having to construct your road as you negotiate your way, at speed, across an ocean to the relative safety of the next lump of land, Can't Drive This is a fast-paced racing game.

## Splash action

Pixel Maniacs then took things up a notch by providing interactive elements, building a mock 4D arcade game (so-named because they feature

Machine creator Pixel Maniacs usually makes PC and console games



▶ This two-player co-operative game involves one player building the track while the other drives along it



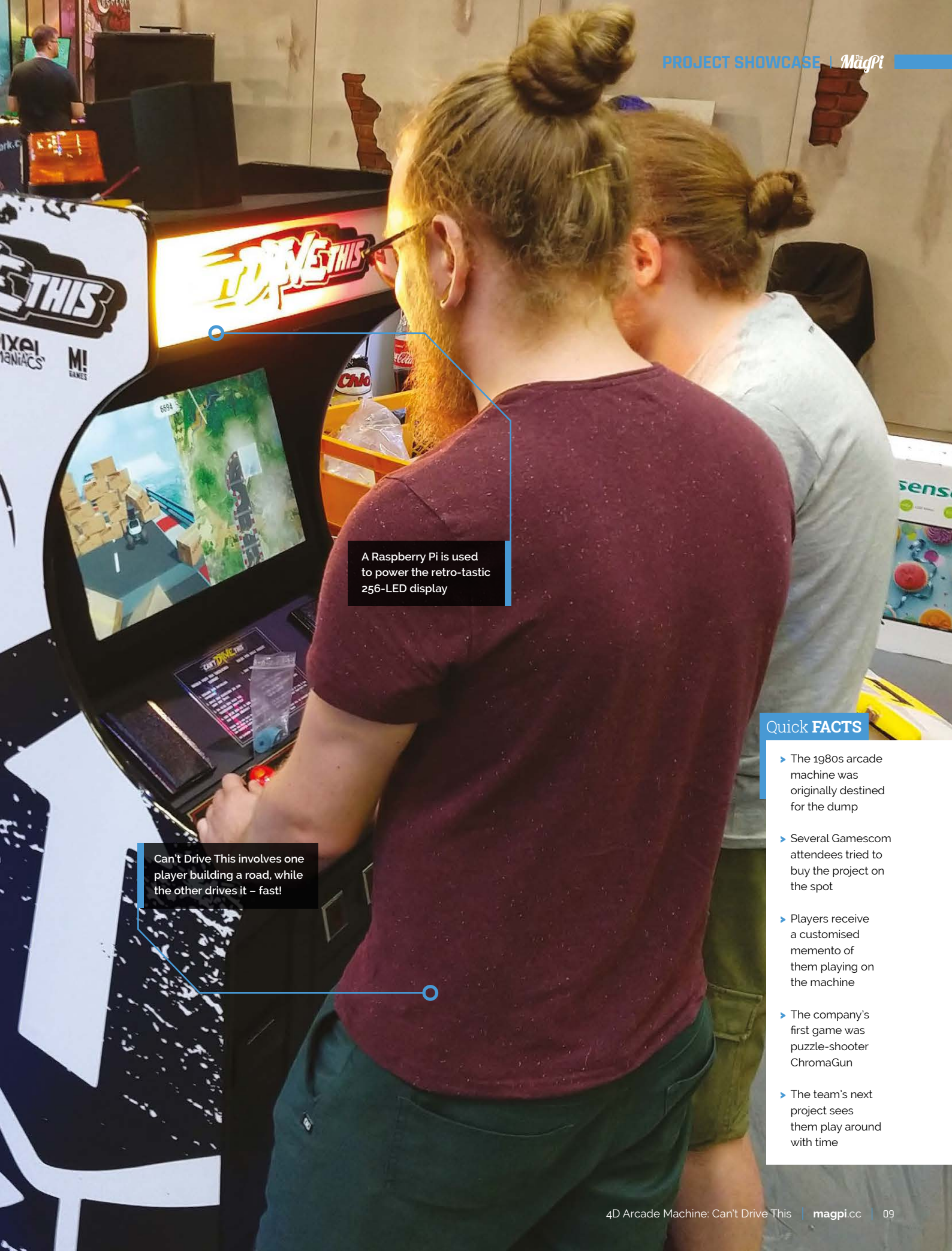

A Raspberry Pi is used to power the retro-tastic 256-LED display

Can't Drive This involves one player building a road, while the other drives it – fast!

### Quick FACTS

- ▶ The 1980s arcade machine was originally destined for the dump
- ▶ Several Gamescom attendees tried to buy the project on the spot
- ▶ Players receive a customised memento of them playing on the machine
- ▶ The company's first game was puzzle-shooter ChromaGun
- ▶ The team's next project sees them play around with time





- ▶ Getting to the heart of the matter and replacing the original 1980s kit with modern-day processors and Pi-powered additions
- ▶ The schematic for the 4D arcade machine, showing the importance of the Raspberry Pi as a controller

interactive elements such as motion cabinets). The fourth dimension in this case saw the inclusion of a water spray, fan, and console lights. For its Gamescom debut, Pixel Maniacs presented Can't Drive This in a retro arcade cabinet, where hordes of gaming fans gathered round its four-way split screen to enjoy the action.

Adding Raspberry Pi gaming to the mix was about aiding the game development process as much as anything. Andy Holtz, Pixel Maniacs' software engineer, told *The MagPi* the team wanted an LED matrix with 256 RGB LEDs to render sprite-sheet animations. "We knew we needed a powerful machine with enough RAM, and a huge community, to get the scripts running."

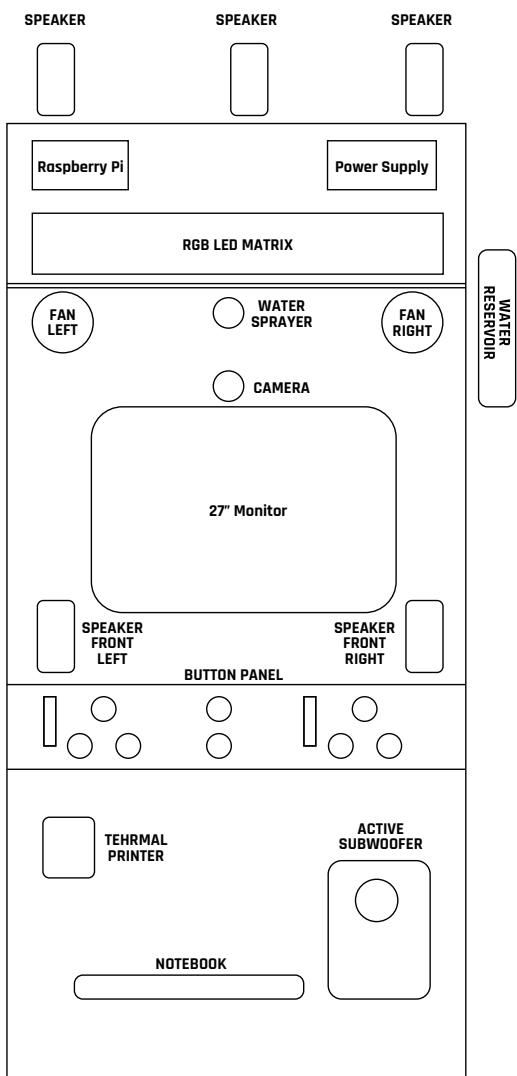

Pixel Maniacs' offices have several Raspberry Pi-controlled monitors and a soundboard, so the team knew the Pi's potential.

The arcade version of the game runs off a gaming laptop cunningly hidden within the walls of the cabinet, while the Raspberry Pi delivers the game's surprise elements such as an unexpected blast from a water spray. A fan can be triggered to simulate stormy weather, and lights start flashing crazily when the cars crash.

Holtz explains that the laptop "constantly sends information about the game's state to the Raspberry Pi, via a USB UART controller. The Pi reads these state messages, converts it, and sends according commands to the fans, water nozzle, camera,

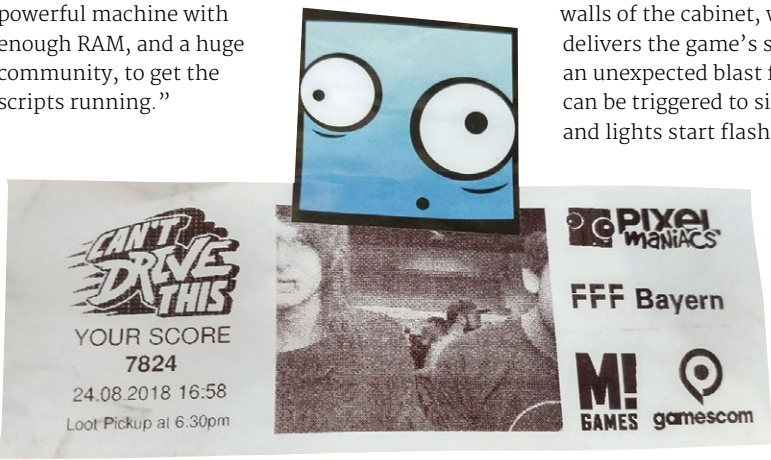

- ▶ Having played your heart out, you get a photo-booth-style shot of you in full-on gaming action





and the LED light matrix. So, when players drive through water, the PC sends the info to the Pi, and [the latter] turns on the nozzle, spraying them.”

The arcade idea came about when Pixel Maniacs visited the offices of German gaming magazine M! Games and spied an abandoned, out-of-order 1980s arcade machine lurking unloved in a corner. Pixel Maniacs set about rejuvenating it, *Da Doo Ron Ron* soundtrack and all.

### Sustained action

Ideas are one thing; standing up to the rigours of a full weekend’s uninterrupted gameplay at the world’s biggest games meet is something else. Holtz tells us, “The Raspberry Pi performed like a beast throughout the entire time. Gamescom was

▲ Pixel Maniacs reprogrammed a hand-held games console controller for the arcade machine

“ The Raspberry Pi delivers the game’s surprise elements such as an unexpected blast from a water spray ”

open from 9am till 8pm, so it had to run for eleven hours straight, without overheating or crashing. Fortunately, it did. None of the peripherals connected to the Pi had any problems, and we did not have a single crash.”

Fans were enthusiastic too, with uniformly positive feedback, and one Gamescom attendee attempting to buy the arcade version there and then. As Andy Holtz says, though, you don’t sell your baby. Instead, Pixel Maniacs is demoing it at games conventions in Germany this autumn, before launching *Can’t Drive This* across gaming platforms at the end of the year. **M**

## Arcade gaming reimagined



**01** A Raspberry Pi 3B+ was used to trigger the water spray, lights, and fans, bringing an extra element to the gameplay, as well as rendering the arcade machine’s graphics.



**02** The transformation from a decidedly unloved-looking eighties console to a modern 4D gaming machine owes a great deal to the team’s imagination, as well as the additions the Raspberry Pi made possible.



**03** *Can’t Drive This* is every bit as engaging and frustrating to play as other driving arcade games, but this one comes with the unexpected jeopardy of getting blasted with water for your troubles.

# The Knitting Network Printer

What can you do with a vintage 1980s knitting machine? You can turn it into a 'Knitting Network Printer', that's what! **Nicola King** picks up her needles and probes a very crafty hack



**Sarah Spencer**

MAKER

An Australian software engineer, Sarah is also a keen maker and crafter who sells her creations in an Etsy shop.

[magpi.cc/fvCnbX](http://magpi.cc/fvCnbX)

**K**nitting is an ever popular pastime that has spanned the decades, but Sarah Spencer has arguably propelled that craft well and truly into the 21st century, using her ingenuity, a slightly dated piece of knitting equipment, and a Raspberry Pi. Sarah has made a hobby of turning a dusty old domestic knitting machine from yester-year into something very special: a Knitting Network Printer that can produce some rather amazing FOs (that's knitting terminology for 'finished objects' for the non-knitters among you.)

## Knitting: 21st century style

Sarah's interest in hacking domestic knitting machines began several years ago. As a software engineer, she was keen to investigate the possibilities of marrying current technology with old, and her 1980s Brother KM950i knitting machine (no longer in production) has undergone something of a transformation over the past few years. The

“When I first picked up a Raspberry Pi, I never imagined in my wildest dreams what I'd end up doing with it”

original machine came with an on-board scanner to scan knitting patterns, and a floppy drive to back them up. Sarah explains, “By using a floppy drive emulator written in Python and a web interface, I can send an image to the Raspberry Pi over the network, preview it in a knitting grid, and tell it to send the knitting pattern to the knitting machine via the floppy drive port [...]. I call this setup OctoKnit, in honour of a more famous and widely used tool,



OctoPrint for 3D printers, another popular application for Raspberry Pi.”

Taking several years to perfect, Sarah has made various modifications to her machine over that time, and explains, “With the addition of a motor arm and an automatic colour changer, my knitting is getting very close to being hands-free.” The machine has also had to become much larger since

she began tinkering, as Sarah adds that she has “specialised in knitting multicolour work using a double-layered technique called double jacquard which requires two beds of needles.”

Sarah's approach is nothing less than practical: “I made a thing that can make things, so I need to make something with it, right?” The items that she has made are impressive, including laptop covers and scarves that she sells via an Etsy store.

▼ Sarah modified a 1980s domestic knitting machine using a Raspberry Pi, which stores patterns and sends them to it via the floppy drive







The grey area represents the Milky Way – our own galaxy

The wavy line through the centre is the Earth's equator projected out into space

Featuring 88 constellations, Sarah's stellar map is 4.6 m wide and weighs 15 kg

### Quick FACTS

- ▶ Software used includes Python, a bit of PHP, and JavaScript
- ▶ The web interface can be found at [magpi.cc/VaTNeL](http://magpi.cc/VaTNeL)
- ▶ 'Stargazing' was commissioned by the EMF festival
- ▶ Its planets are aligned for the EMF opening time
- ▶ Sarah makes personalised knits to order via Etsy

Her pièce de résistance, however, is extraordinary and on a very different scale... Stargazing: a knitted tapestry ([magpi.cc/ZsvAja](http://magpi.cc/ZsvAja)).

### Out of this world

A huge undertaking that is 15ft (4.6m) in width, this celestial map of the night sky features all 88 constellations across both northern and southern hemispheres. Sarah explains that this heavenly piece of work was “knitted in seven panels stitched together by hand. The pattern on the Raspberry Pi is 21 times bigger than the memory available on the vintage knitting machine, so it’s knitted in 21 separate but seamless file transfers. It took over 100 hours of work, and weighs 15 kg.”

“When I first picked up a Raspberry Pi,” says Sarah, “I never imagined in my wildest dreams what I’d end up doing with it.” Well, she’s done something pretty amazing with it, and whether you’re a knitter, hacker, or simply an admirer of cleverness, knitting never looked so good. [M](#)

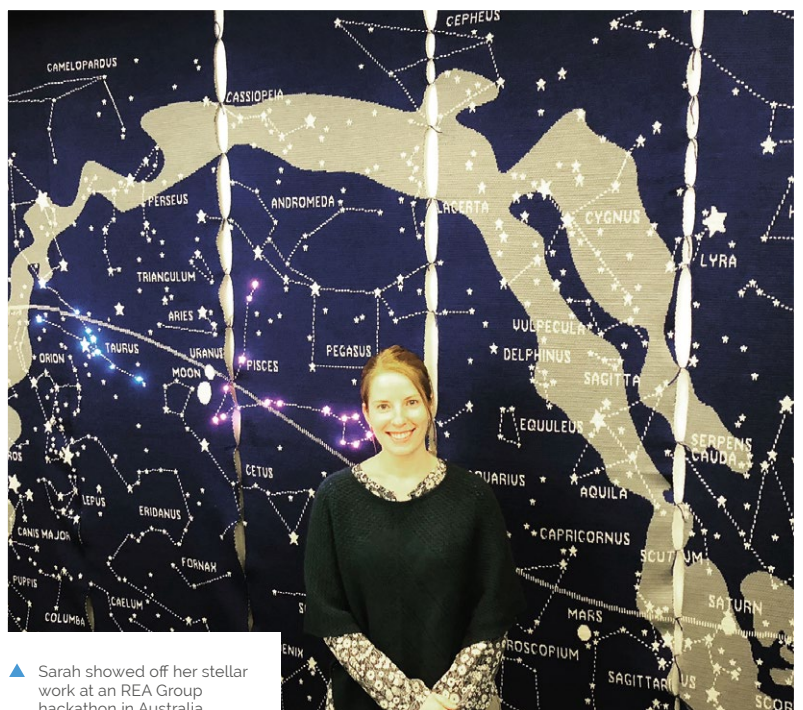

▲ Sarah showed off her stellar work at an REA Group hackathon in Australia



# 75

# GREATEST RASPBERRY PI PROJECTS

We celebrate 75 issues of The MagPi with 75 amazing projects from around the community!

**A** couple of years ago *The MagPi* hit 50 issues, so we thought we'd celebrate by putting together a list of the best 50 projects ever made. In the short amount of time between then and now, the Raspberry Pi community has gone above and beyond and created some incredible

builds – more than enough to showcase 75 more amazing projects!

As we're the community magazine, we wanted the community to have a say in this list, so the top 50 projects on this list were voted for by you, the readers. Read on to find out what you folks think is the best project of the last two years...



Credit: Conner Ballard



Credit: Conner Ballard



Credit: Conner Ballard







Credit: Conner Ballard

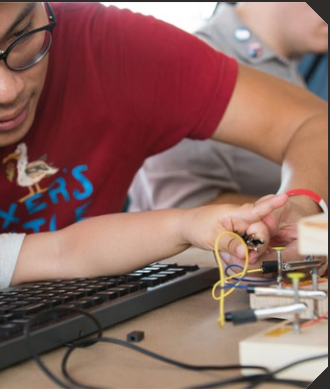

Credit: Conner Ballard



Credit: Conner Ballard

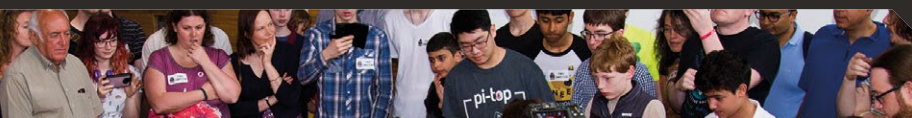



# Amazing AI Projects

**Eben Upton** picks his five favourite AI projects

**W**e've seen an explosion of projects that make use of AI in the Raspberry Pi community over the last year or so, and while we like to think we helped to kick-start this with the AIY Projects issue of *The MagPi*, the community has run far beyond that initial kit. Eben tells us his favourite AI projects that he's seen.



03

## Zoë and Hermione Autonomous drones

- > Andy Baker
- > [pidrone.io](http://pidrone.io)

I was there for Andy's flammable drone demo at the Birthday Party, so it was great to see it rising like an AI-powered phoenix from the ashes.



02

## Raspberry Pi Engine Control Real-time engine management

- > Adam Vaughan
- > [magpi.cc/ZqPXhU](http://magpi.cc/ZqPXhU)

As Liam Fraser will attest, I'm a closet petrolhead, so seeing people do engine control of any sort with a Raspberry Pi is always a pleasure. Add in the machine learning angle and this is a really sweet demo of what you can do with Raspberry Pi in a deep-embedded environment.

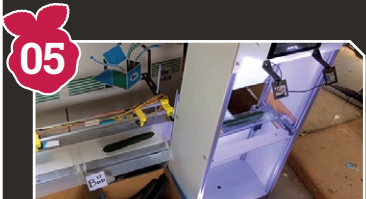

05

## Cucumber sorter Automating vegetable grading

- > Makoto Koike
- > [magpi.cc/fDeLLK](http://magpi.cc/fDeLLK)

My all-time favourite. This is a lovely example of an individual engineer solving a very specific personal problem, using Raspberry Pi as a bridge between imaging, I/O, and (local) machine learning.

01



The plastic hand really completes this daft yet amazing project

## There's Waldo Find the elusive Wally

- > Matt Reed
- > [magpi.cc/LaGzbn](http://magpi.cc/LaGzbn)

I've never been a big fan of Where's Waldo/Wally/ whoever, so using machine learning to automate the process of completing (and discarding) each book is very appealing to me.

04



## Solar Pilot Guard Making flying safer

- > Foale Aerospace, Inc
- > [magpi.cc/fHoUra](http://magpi.cc/fHoUra)

Like a lot of people at Pi Towers, I'm a massive space cadet, so learning that Michael Foale has been using

our product (and Wolfram Mathematica) is very exciting. I loved the idea of him repeatedly flying his aeroplane unsafely in order to gather enough training data for the machine learning algorithm.



**Eben Upton**

CEO, Raspberry Pi (Trading) Ltd



01

# Stunning Art Projects

**Liz Upton** shows us five projects using Pi to make art

As more people grow up with accessible computing technology, we've seen many more art projects incorporate computers and technology in some way. Liz tells us some of her favourite examples of these arty projects in the intersection of STEAM.



You must defeat my arpeggio to stand a chance

## Sound Fighter Hadoukens in D minor

- > Foobarflies
- > [magpi.cc/fZxPGD](http://magpi.cc/fZxPGD)

Not just one of my favourite creative projects for the Pi, but probably my favourite project of all time. Two pianists play music, which also controls the angry people in Street Fighter.

## Joytone A new instrument

- > David Sharples
- > [magpi.cc/XxbZSE](http://magpi.cc/XxbZSE)

A completely new musical instrument, built around a hexagonally isomorphic layout which ensures that musical structures will have the same shape in whatever key they're played. Revolutionary, clever, and really satisfying.



03

## Drop Pi Automated water droplet photography

- > David Hunt
- > [magpi.cc/fvNmeA](http://magpi.cc/fvNmeA)

An oldie but a goodie: less than a year after the first Raspberry Pi was released, we started to see it being used as a piece of inexpensive photographic hardware. Dave Hunt's gorgeous water droplet photography uses the Pi to coordinate a solenoid valve and camera shutter to stunning effect.



04

## After Dark Night in the museum

- > The Workers
- > [afterdark.io](http://afterdark.io)

What's creepier than a locked museum after dark? A locked museum after dark full of robots, that's what. This project allowed people to look through the eyes of wandering robots in Tate Britain after the witching hour.

Credit: Alexey Moskvkin, Tate Britain



**Liz Upton**

Director of Communications, Raspberry Pi Foundation



02

## Paludarium Amazon rainforest simulator

- > Poopi & Piter
- > [magpi.cc/ZhEiVV](http://magpi.cc/ZhEiVV)

I wrestled a bit here. Does this fall under creative projects or conservation? I reckon it ticks both boxes: it's a simply beautiful object I could stare at for hours, as well as a working Amazonian wildlife habitat.

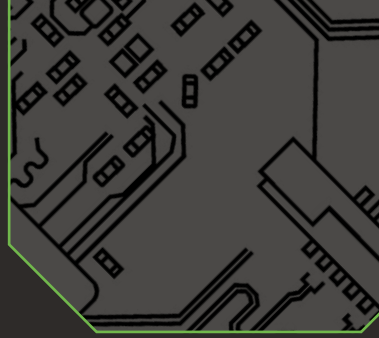

# CoderDojo's Coolest Projects

Young makers at CoderDojos make amazing things too

**W**e're taking a break from showing you just amazing projects to also highlight some of the coolest creations from the CoderDojo's Coolest Projects events! These events feature amazing projects created by young makers from CoderDojos around the globe. Here are five incredible ones, but there are many more you can find at [coolestprojects.org](http://coolestprojects.org).

## Welcome Here Supporting refugee communities

► Jeroen ► [magpi.cc/GhdBjg](http://magpi.cc/GhdBjg)

In the winter of 2016, many refugees were making their way to Europe. To try to help them adjust to their new homes, the then 15-year-old Jeroen decided to make an app for them.

"I had the opportunity to talk to refugee assistance organisations in Belgium and France," says Jeroen. "They were enthusiastic to help me and they also gave me inspiration on the content and the conversations in the app."

Jeroen's story found its way to local and international news, and he won the Future Makers category at Coolest Projects 2017.

01



Find out more about CoderDojo, along with info on how to start your own Dojo here: [coderdojo.com](http://coderdojo.com)

02

## Light up my helmet Enlightened bike safety

► Kobe  
► [magpi.cc/vcipGF](http://magpi.cc/vcipGF)



Kobe is an avid cyclist, and he cycles to school every day. This means that for a good portion of the year, he's cycling in the dark. "Making

because it is much safer in case you would fall or crash."

As well as the helmet being decked out in a load of LEDs, and a battery to power it, Kobe

“ Making something that makes you more visible in traffic would be a good improvement ”

something that makes you more visible in traffic would be a good improvement," he says. "I always wear a helmet,

has installed a wireless remote control on the handlebars so he can activate indicator lights, much like you see on a car.

See the 'light up my helmet' in action over on YouTube: [magpi.cc/sUbudK](http://magpi.cc/sUbudK)





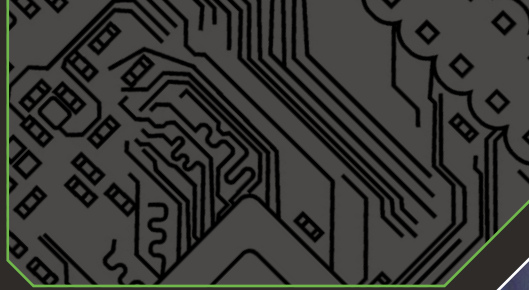

04

## Amy's Buzzy Hive

### Save the bees

- Amy
- [magpi.cc/RaUYPd](http://magpi.cc/RaUYPd)

"Malvina, one of our mentors, said 'Wouldn't it be great to do something to help the environment?'" recalls Amy. "Another mentor keeps bees and said that the bee population is in danger (and that means no honey!), so I decided to do a project on a way to maybe find out why."

Amy's project uses several sensors hooked up to a Raspberry Pi inside a beehive, which tracks bees' numbers in an attempt to identify the cause of dwindling populations.



## Donate Hair for Cancer Wigs

### Helping sick kids

- Andrea
- [magpi.cc/WZLCPC](http://magpi.cc/WZLCPC)

Andrea's project takes the form of a short story that the seven-year-old created in Scratch. Andrea wanted to share the message about how donating hair can help out young patients who have cancer.

"Coolest Projects 2017 was the perfect place with so many kids attending from all around the world," says Andrea. "I was hoping that they can see my project and to accept this cool idea for supporting kids with cancer."

03



Raspberry Pi Foundation CEO Philip Colligan got a chance to see the project

05



## The Lost World

### A post-apocalyptic game

- Matei
- [magpi.cc/kXcAdm](http://magpi.cc/kXcAdm)

Ten-year-old Matei loves science fiction, and came up with the idea for his game after reading some books set in a post-apocalyptic world. Instead of the usual gloomy setting, Matei's game has a more hopeful outlook for humanity's future.

To create the game, Matei taught himself how to use the Unreal Engine, with some help from mentors at his local CoderDojo. An amazing achievement at age ten, which earned him the prize for the best Games Under 12 award.



# Projects for Good

Philip Colligan reveals his top-five world-changing Pi projects

As well being an amazing computer for learning, the Raspberry Pi is a powerful force for good. From environmental protection to healthcare and citizen science, folks around the world are doing remarkable things with our favourite single-board computer. CEO of The Raspberry Pi Foundation, Philip Colligan shares his favourite projects with us.

## Diabetic Foot Health

Telemonitoring and drying of diabetic foot ulcers

► Ernesto Holguin ► [otenmedical.com](http://otenmedical.com)

We met Ernesto Holguin from El Paso in Texas at the Houston Maker Faire, showing off his fantastic Diabetic Foot Health machine. It utilises the Raspberry Pi 3 to inspect feet, dry them, take images, and communicate other vital sign information with clinicians and family members. One in five diabetic patients visit a clinic about ulcerative wounds, and this machine improves the frequency of skin monitoring.



Philip Colligan

CEO, The Raspberry Pi Foundation



## Arribada

Harnessing green sea turtles for conservation

► Alasdair Davies  
► [blog.arribada.org](http://blog.arribada.org)

Arribada is the latest initiative from the amazing Alasdair Davies, a technologist, Pi enthusiast, and conservationist who is on a mission to make low-cost conservation technologies. Alasdair has created a turtle tag using Raspberry Pi Zero W and Camera Module that literally allows us to travel with the turtles. Amazing.



## Mazi

Do-it-yourself wireless networks

► Mazi  
► [mazizone.eu](http://mazizone.eu)

Mazi uses Raspberry Pi to create hyperlocal wireless networks that are being used by communities from Athens to Zurich to fuel social innovation projects. Mazi was just one of the Pi projects that I saw on a recent visit to the amazing Knowledge Media Institute at the Open University.

Credit: Freifunk.net



## Project Rover

Semi-autonomous bomb disposal

► Staff Sergeant Jolley, Sergeant Rana, & Sergeant Paddon  
► [magpi.cc/cbRVjY](http://magpi.cc/cbRVjY)

This brilliant use of a Pi came out of a British Army Foreman of Signals training programme. What I love about it is that the three soldiers behind the invention had limited programming experience, but were able to quickly develop a robot that could sense and avoid obstacles.

## Fesentience

Tackling neonatal abstinence syndrome

► Engineering and Science University Magnet school (ESUMS)  
► [magpi.cc/BikRuh](http://magpi.cc/BikRuh)

The team at Fesentience is using the Raspberry Pi to create a product that can mimic the maternal womb to help babies born with neonatal abstinence syndrome. A great example of Pi powering innovations in healthcare, which I predict will be one of the most exciting fields for applications of the low-cost computer in the next few years.



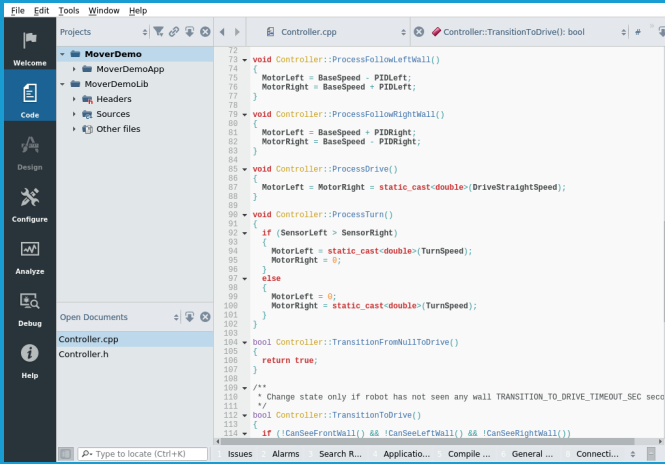

Code

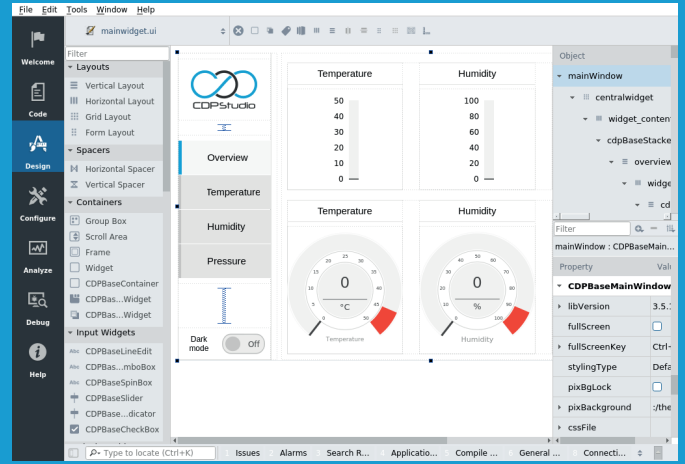

Design

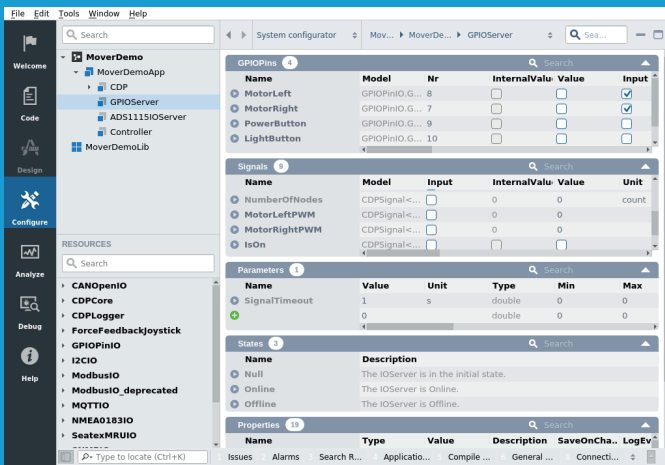

Configure

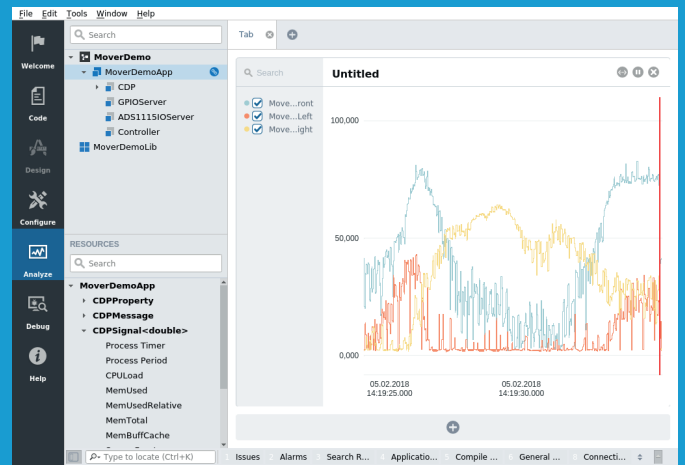

Analyze

# Now free for home projects

## A professional control system development tool

CDP Studio is a development platform for industrial control systems, now coming with a free version for non-commercial use. The system can run on a Raspberry Pi, supports C++, open source libraries and has a large feature toolbox including GPIO, I2C and MQTT. Its built in GUI design tool and features lets you code less and do more.

Free download on [www.cdpstudio.com](http://www.cdpstudio.com)

CDP Technologies AS  
Nedre Strandgate 29  
P.O. Box 144  
NO-6001 Ålesund, Norway

Tel: +47 990 80 900  
info@cdptech.com  
www.cdpstudio.com



# Greatest Educational Projects

Carrie Anne Philbin with five amazing uses of Pi for learning

Learning is right at the heart of the Raspberry Pi experience, and an uptake in education was the driving force behind the board's original development. The Raspberry Pi Foundation's Carrie Anne Philbin selects her favourite educational projects.

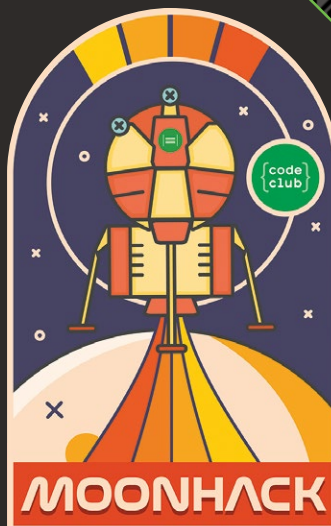

## Moonhack

Breaking the code world record



- > Code Club
- > [moonhack.com](http://moonhack.com)

Moonhack is Code Club's free world-record-setting event for kids aged 8-18 around the world. Held on 20 July (the anniversary of the Apollo 11 Moon landing), it entails kids all over the globe getting involved with coding projects. Every year it gets bigger, and Moonhack 2018 saw 35 865 kids from 58 different countries taking part.

## Digital Maker Staged Activity Badge

Making with the Scouts

- > Scouts
- > [magpi.cc/VgdKij](http://magpi.cc/VgdKij)

Getting digital making into kids hands is what the Raspberry Pi Foundation is all about, and the new badge activities we developed with the Scouts are a fantastic way to reach out to more children who may be interested in computing.



Carrie Anne Philbin

Director of Informal Learning



## Agrihack

Solving farming problems with a Raspberry Pi

- > Agrihack
- > [magpi.cc/BSrjgg](http://magpi.cc/BSrjgg)

Agrihack brings together Australian children, coders, and farmers to solve problems with technology. The Hackathon challenges are: reducing stored grain spoilage from high moisture, measuring the live weight of meat chickens to prevent overfeeding, and assisting the handover of farms and fisheries from the older to the younger generation.



## BBC Computer Literacy Archive

A golden era of computer education projects

- > BBC
- > [magpi.cc/nqHDem](http://magpi.cc/nqHDem)

If you've ever wanted to know more about the history of British home computing, a whole treasure-trove of interviews, TV shows, programming code, and photos has been assembled for your delectation and inspiration. The BBC's archive of its Computer Literacy Project (CLP) is packed with professional educational resources from a ten-year endeavour to teach the nation computer skills.



The simple way to mount your Pi!

- Industrial DIN rail mount
- Open frame for better airflow
- Integrated USB strain relief



Pi Zero version





# TOP 50

## READER VOTED PROJECTS

A voted for by you, the readers, here are 50 Raspberry Pi projects

50



### Hoverbot

A robot made from a hoverboard and an old table

- > Isabelle Simova
- > [magpi.cc/CDEbOq](http://magpi.cc/CDEbOq)

While countless Raspberry Pi robots have been created, most of them are on the small side. Hoverbot, however, bucks this trend and comprises upcycled parts including a hoverboard and an IKEA table. Hoverbot is a large robot that is equipped with sonar sensors for obstacle detection and is powerful and sturdy enough to transport heavy items and even people.

### QBee

The dress that awards points for social interaction

- > Clodagh O'Mahony
- > [magpi.cc/xUoouA](http://magpi.cc/xUoouA)

For her thesis project, Clodagh created a dress and an accompanying website to comment on the progression of social media interaction. Clodagh created a corporation named 'QBee', an abbreviation of Queen Bee, with the associated honeycomb theme playing a significant part in the look of both the dress and website. This corporation, if given true life, would provide a range of wearable tech – similar to her dress – that would allow for the recording of social interaction data, updating it to the wearer's online QBee account.



49

### Dog Treat Machine

With motion detection and video capture

- > Eric Page
- > [magpi.cc/2sTf5qU](http://magpi.cc/2sTf5qU)

While pondering what to get Shirin, his fiancée, for her birthday, Eric Page realised how much she misses her dog Pickles while she's at work. He decided to build a Dog Treat Machine to allow her to serve treats to Pickles remotely. There are four ways to trigger the Pi-powered device: email, MQTT, IFTTT, or Alexa. It then plays a sample of Shirin's voice, dispenses some dog treats, and checks for motion using OpenCV analysis.

48



### Museum in a Box

Experience artefacts from afar

- > Museum in a Box
- > [museuminabox.org](http://museuminabox.org)

Pop a museum object on top of the box and it will start telling you about itself. Through 3D-printed models and wooden sculptures, 2D images such as postcards and photography, and 'do it yourself' feedback cards, the team aim to break the disappointing, yet often necessary, Do Not Touch stigma of museums, allowing everyone the chance to get to grips with a history they may otherwise miss out on.

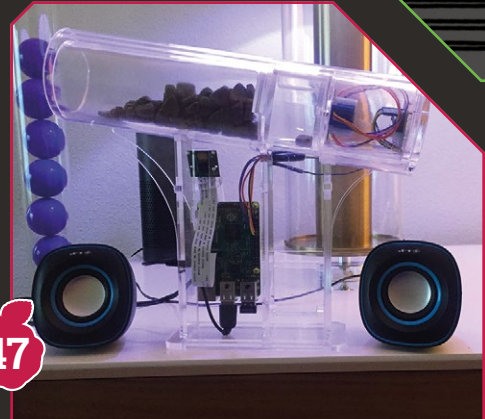

47



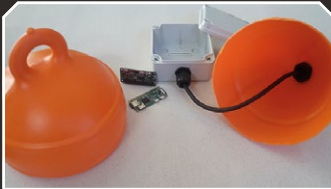

## Nemo Pi

An underwater weather station

46

- Diemo Niemann
- [save-nemo.org](http://save-nemo.org)

For the past two years, the Save Nemo Foundation has worked hard to protect coral reefs off the coast of Thailand and Indonesia. Its members have been sinking concrete blocks next to the reefs, allowing diving and snorkelling boats to safely moor by using them as anchor points. Nemo Pi is a smart buoy able to measure temperature, visibility, pH levels, and the concentration of CO<sub>2</sub> and nitrogen oxide at each anchor point.

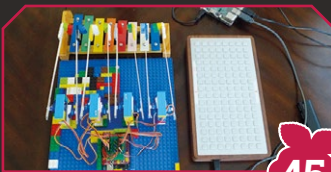

## MonomePi

A music box featuring old and new technology

45

- Joon Guillen
- [magpi.cc/uDPImr](http://magpi.cc/uDPImr)

With hammers hitting the bars of a toy glockenspiel to play a tune, the Monomepi sounds just like an old-fashioned music box, but this Pi-powered contraption is based on new technology... and quite a lot of Lego. The Monome is connected to a Raspberry Pi 3 running a step sequencer program, which registers the user's button presses on the Monome and lights them up accordingly.

## Tomy Turnin' Turbo Dashboard Out Run

Classic video game in a toy

- Matt Brailsford
- [circuitbeard.co.uk](http://circuitbeard.co.uk)

44

Matt Brailsford, picked up a Tomy Turnin' Turbo Dashboard on eBay and had a spark of genius: why not turn it into a fully working Out Run arcade machine? Matt tells us it's fun to play. "It was a little squeaky to start with, but I had just tightened everything up a little too much. It runs nicely and brings back those memories as a kid. It's how I thought it felt to play with back then."



## SoFi robot fish

This robotic fish swims with real ones

- Robert Katzschmann
- [magpi.cc/kjsBkZ](http://magpi.cc/kjsBkZ)

43

In the depths of the South Pacific, a strange new fish is exploring the Rainbow Reef. Flexing its tail from side to side to propel itself serenely along, it captures the underwater scene using a camera – with a fish-eye lens! – mounted in its head, which also contains a Raspberry Pi 2, among other electronics.

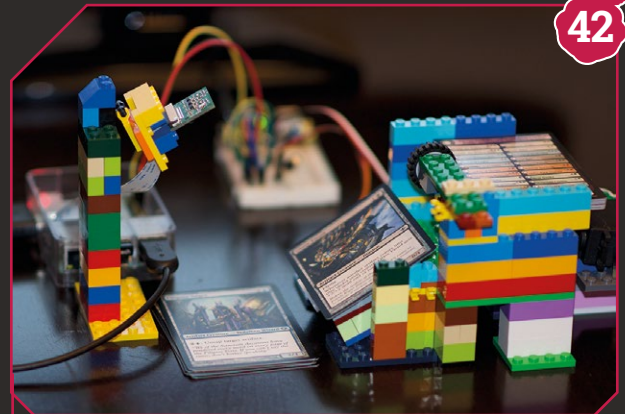
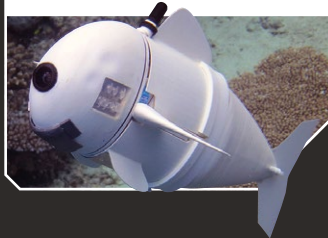

## Trading card scanner/organiser

Using Lego to scan card collections

- Michael Portera
- [magpi.cc/YyscOC](http://magpi.cc/YyscOC)

Michael envisaged a simple system that would spin and push preloaded cards forward to be photographed and uploaded for digital storage and processing. The idea was to make light work of organising and valuing even the largest of collections.

## C-Turtle

This mine detector could save lives

- Kevin S Luck
- [magpi.cc/2yzh4pu](http://magpi.cc/2yzh4pu)

It's a sad truth, but right now the world is littered with an estimated 110 million land-mines. C-Turtle uses machine learning to figure out how to walk across the most unusual and hazardous of terrain, constantly adapting to its surroundings.

41

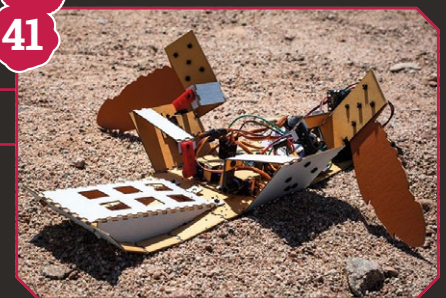



40

### Fruit Nanny

A better baby monitor

> Dmitry Ivanov  
> [magpi.cc/2jy01v0](http://magpi.cc/2jy01v0)

This advanced baby monitor was created due to frustration with the limitations of commercial baby monitors. Dmitry originally put all the pieces in a lunchbox before upgrading to a custom case – it includes a microphone, an IR camera, and can be accessed via a web browser.



### 3D Pac Robot Man

A real-life classic

> Emanuele Coletta > [magpi.cc/FFVwSt](http://magpi.cc/FFVwSt)

Pac-Man is a timeless classic that has been remixed and remade in many ways, including cult-classic Pac-Man Vs. In this edition of the game, one person controls Pac-Man in the maze, while friends control the ghosts and try to stop them. Emanuele's version takes the concept one step further by creating the maze and characters in real life using robots.



39



38

### Ghost Detector

Who you gonna call?

> Anthony Dipilato  
> [magpi.cc/bLPSrp](http://magpi.cc/bLPSrp)

Anthony's Ghost Detector is actually a present for his father, an avid watcher of paranormal investigation shows. It started off as an electromagnetic field meter, but an IR camera was added to the build. While the case resembles wood, it's actually 3D-printed.



37

### PiOrder

Pi-powered takeaway

> Ehsan Rahman  
> [magpi.cc/2mFCdZB](http://magpi.cc/2mFCdZB)

Automation is easy with a Raspberry Pi. and Ehsan decided to use it to create an order system at his father's restaurant. It connects to some tablets which waiters use to take orders, and they're then printed out via the Raspberry Pi.

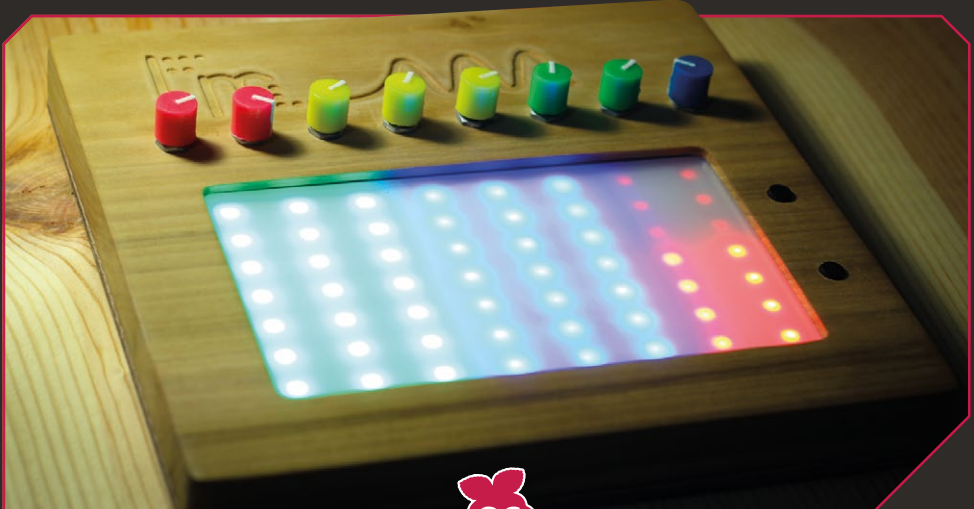

36

### PolaPi-Zero

Recreates the joy of using a Polaroid

> Toby Hendricks > [magpi.cc/tcGRGh](http://magpi.cc/tcGRGh)

Toby, aka musician Otem Rellik, was frustrated with iPad music apps. So he decided to make his own using a Pi Zero and the Pure Data programming language. What started out as an experiment turned into a wonderful-looking, multifunctional synth.

What started out as an experiment turned into a wonderful-looking, multifunctional synth





35

## Instagif NextStep

The printable GIF

- > Abhishek Singh
- > [magpi.cc/2yKkc1T](http://magpi.cc/2yKkc1T)

This fun project obviously doesn't print a moving image – instead, Abhishek has made it so that a very short video is uploaded to a cartridge which looks like a Polaroid picture and houses a small screen. You insert the cartridge into the front of the camera and it spits it out once it's ready.



## Cocktail machine

Automated libations

- > Stefan Höving
- > [magpi.cc/uiTVEP](http://magpi.cc/uiTVEP)

33

While making a cocktail by hand can be fun (especially when you fudge the measurements), it's also very cool to be able to have a cocktail dispensed straight into a glass. It's all a bit *Star Trek*. We especially like the classy presentation of this Pi-powered booze maker.

## Raspberry Turk

Play chess against a robot

- > Joey Meyer
- > [raspberryturk.com](http://raspberryturk.com)

The Mechanical Turk was an old parlour trick where a chess master would sit in a box and control a dummy so it looked like it could play chess automatically. The Raspberry Turk is not a trick: it's an actual robot you can play chess against. And that's pretty cool.

34



## Aphex Twin Midimutant

An evolving synthesiser

- > Dave Griffiths & Richard James
- > [magpi.cc/hptLSQ](http://magpi.cc/hptLSQ)

Instead of manually programming a synth yourself, the Midimutant runs through endless combinations to create a new series of synth sounds through code mutations and mixing. After a couple of hours, it usually produces something that sounds good.

32

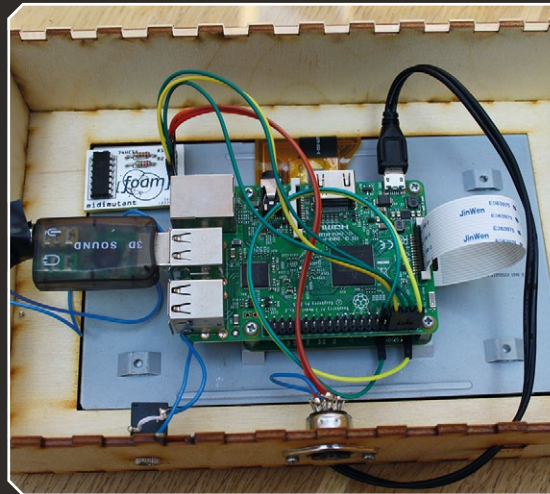

## Mambot

What can't this robot do?

- > Ahmed Al-Faris
- > [magpi.cc/PKxzfz](http://magpi.cc/PKxzfz)

Raspberry Pi robots can be expanded and built upon quite a lot, but we've never seen a robot with this many functions. It has a manipulator arm, five control methods (including autonomous), video streaming, Alexa voice interaction, obstacle avoidance, and can even do order picking. A true renaissance-bot.

31





30

## PolaPi-Zero

Recreates the joy of using a Polaroid

> Pierre Muth > [magpi.cc/beJzih](http://magpi.cc/beJzih)

We've seen many digital camera builds using the Raspberry Pi and Pi camera. From 3D-printed cases to retrofit vintage classics, the majority act as simple point-and-shoot camera. The PolaPi-Zero, however, takes its lead from the iconic Polaroid, utilising a thermal printer within its body to deliver instant prints of your subject matter.

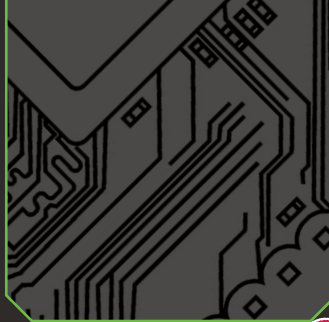

29

## Seeing Wand

It speaks an item's name

> Robert Zakon  
> [magpi.cc/kKzCmJ](http://magpi.cc/kKzCmJ)

Robert Zakon has built a Seeing Wand that can speak the name of whatever it's pointed at. Housed in a makeshift PVC tube, a Pi Zero is connected to a Camera Module that takes a photo when a push-button is pressed. The image is sent to Microsoft's Cognitive Services Computer Vision API to get a description, which is then spoken.

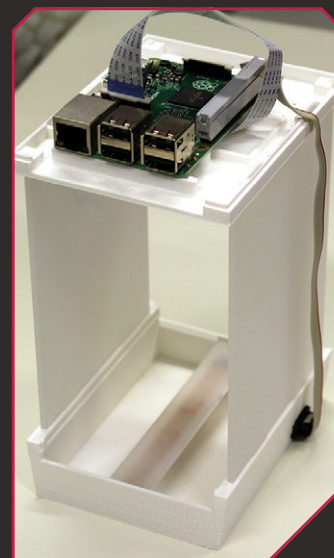

## Ethoscope

Scientific study aid

27

> Giorgio Gilestro  
> [magpi.cc/2i3vTHt](http://magpi.cc/2i3vTHt)

When a group of researchers looked for a low-cost way of conducting studies in neuroscience, they turned to our favourite computer. The result is a machine with the potential to make ground-breaking discoveries about common human behaviour. And its secret ingredient? A load of flies!

## Pi Film Capture

Converting old film reels to digital video

> Joe Herman  
> [magpi.cc/AfykKA](http://magpi.cc/AfykKA)

Restoring home movies captured on film can be a real challenge. Film conversion is a time-consuming and often expensive task. One maker, Joe Herman, took matters into his own hands by hooking up a Raspberry Pi Camera Module to an old projector.

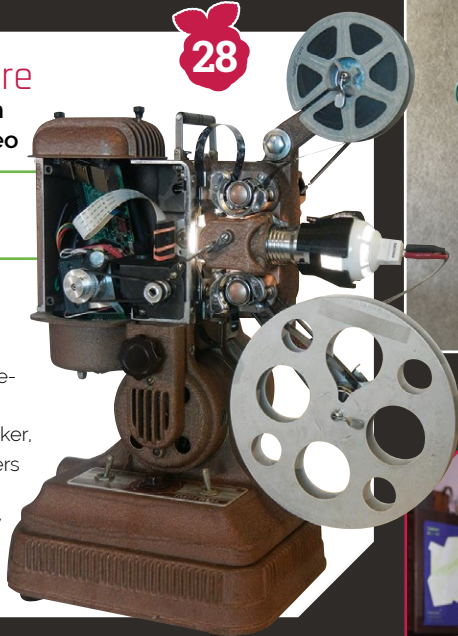

28

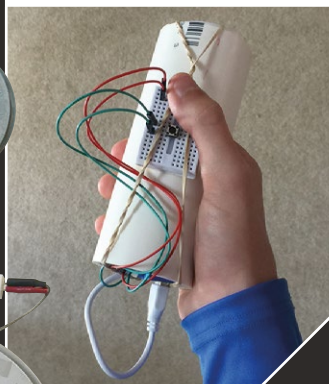

## Teefax

Teletext makes a comeback

> Peter Kwan > [magpi.cc/qGYOkS](http://magpi.cc/qGYOkS)

We're delighted that teletext has been revived by the Teefax project. Users can install the free software ([magpi.cc/2dssVe0](http://magpi.cc/2dssVe0)) on a Raspberry Pi, connect its 3.5 mm video output to a TV (via the SCART socket), then hit the teletext button on the remote control.

26







25

### Security Robot

This robot security guard is an arresting sight

► Josh Starnes  
► [magpi.cc/2DNur9h](http://magpi.cc/2DNur9h)

Inspired by sci-fi movies such as *Short Circuit*, *Evolver*, and *Star Wars*, Josh got to work on an affordable DIY robot that can trundle around the streets, operate in cold and wet weather, work well in low light, and communicate.



### Little Green Tower

An aeroponics tower that grows some tasty veg

► Chris Johnson  
► [magpi.cc/GDOzUk](http://magpi.cc/GDOzUk)

“For the last five years I have been designing and refining an aeroponics tower system that is particularly well-suited to growing leafy green vegetables,” Chris tells us. “The goal is to design a computer-controlled, modular, compact, and low-cost aeroponic system that is easy to replicate.”



22

### Pi Deck

Digital music can't be scratched – or can it?

► Daniel James  
► [64studio.com](http://64studio.com)

Daniel and his colleague Chris Obbard at 64 Studio put a Raspberry Pi 3 alongside a standard vinyl deck, eliminating the hassle and expense of hooking digital decks to a laptop. They figured that all you need is a USB stick packed with music files. “As long as there is low latency in both directions of travel, you can make effects such as rubbing the kick drum beats, scratching, and backspins sound, feel and look realistic,” Daniel says.

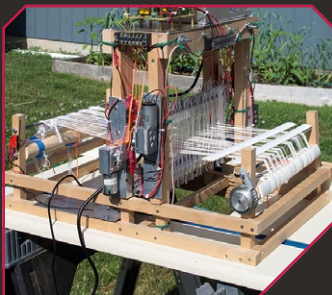

23

### Pi Loom

A weaving wonder controlled entirely by Raspberry Pi

24

► Fred Hoefler  
► [magpi.cc/eoZTUx](http://magpi.cc/eoZTUx)

When Fred Hoefler sent back a computer-controlled tabletop loom after it stopped working with his MacBook Pro, his wife Gina suggested that he should be able to build one with “one of those Raspberry Pi things of yours.” Fred recalls, “The most reasonable answer I could come up with was: ‘as a matter of fact, I think I can.’” A project was born.



21

### Steampunk Pi Jukebox

Retro-futuristic music-streaming device

► Matt Van Gastel ► [magpi.cc/2CRrL6Z](http://magpi.cc/2CRrL6Z)

Matt has turned the main assembly of a 1930s Westinghouse radio receiver into a Pi-powered modern player. He began the project by tearing out the innards from the old tube amplifier. “I had looked at making an actual tube amplifier, but the cost was too high for the quality,” Matt tells us. “But I found the JustBoom site and found this HAT fitted the bill.”







## Aquaponic Domestic Garden

Veg and fish living in harmony

► Diego Braga ► [magpi.cc/FLTVFM](http://magpi.cc/FLTVFM)

Aquaponics is a bit different from hydroponics – in this method, plants and fish co-exist and create their own ecosystem to feed each other. The fish fertilise the plants, and nutrients from the wet soil drop down into the tank below.

20



18

## Teslonda

Half-Tesla, Half-Honda, all Pi

► Jim Belosic & Michael Mathews ► [magpi.cc/NiQMmj](http://magpi.cc/NiQMmj)

This amazing hybrid uses a Raspberry Pi as an on-board computer which monitors the motor and allows you to configure it. It features a retro, eighties-style display and uses toggle switches to complete the old-school aesthetic. Jim uses it for drag racing and it's extremely fast.

## LED-Matrix Table

Tetris under coffee

► Andreas Rottach  
► [magpi.cc/EWRCvg](http://magpi.cc/EWRCvg)

We've seen a few tables that have displays in them, but none that looks like this table made by Andreas. You can play several games on it, but honestly the gaming aspect isn't the most interesting – it's the custom, giant pixels that provide amazing imagery.



16

## Photo Booth

DIY wedding photography

► Jack Barker  
► [magpi.cc/2sNsRic](http://magpi.cc/2sNsRic)

Photo booths at wedding receptions are all the rage at the moment. Jack realised he could make something better with a Raspberry Pi though, and created a Pi-powered photo booth for his own wedding. It even gives you posing advice!

19



## Ghost Chess

Ghost in the pawn

► Tim Ness, Alex Angelov,  
& Alex Smith  
► [magpi.cc/LxbagV](http://magpi.cc/LxbagV)

Chess software is readily available these days, so it was easy for Tim to get it running on a Pi. The real trick was inventing a system whereby a semi-hidden robotic arm moves chess pieces using electromagnets, all dictated by the chess software.

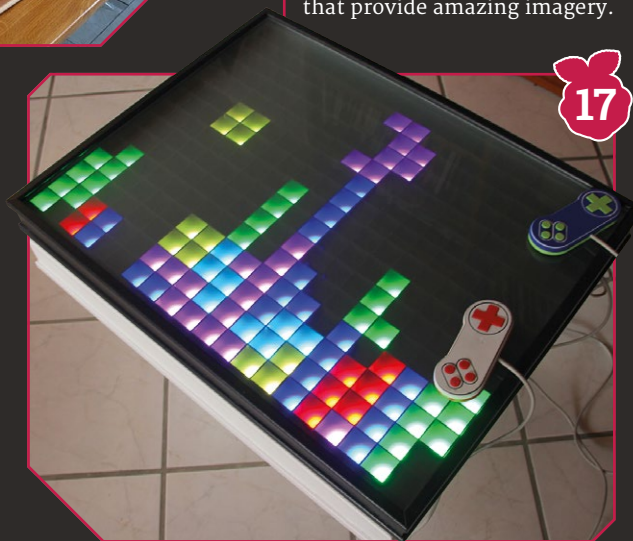

17





## Lunchbox Arcade

Burger time or BurgerTime?

- Daniel Davis
- [magpi.cc/Aivheb](http://magpi.cc/Aivheb)

15

When you've already built a full-size arcade cabinet, the only way to go is smaller. Daniel wanted to make a more portable arcade device, and after purchasing an old metal lunchbox, that's exactly what he did.



14

## Space Weather Station

Extraterrestrial forecasting

- Alex Schwarz
- [magpi.cc/gpwrsv](http://magpi.cc/gpwrsv)

Is there weather in space? The short answer is yes, and Alex's weather station makes use of radio waves to keep an eye on it. It 'listens' for solar wind and any changes in the Earth's magnetic field, which is then tracked by graphs.

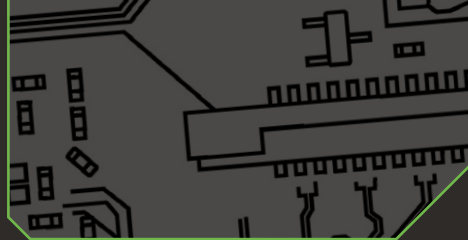

## Tracking Telescope

Automated star following

- Mike Hamende
- [magpi.cc/MLwYio](http://magpi.cc/MLwYio)

13

Automatic tracking is something a lot of higher-end telescopes do, but with a bit of know-how and a custom-built mount, Mike was able to get a Raspberry Pi to control his telescope. It makes it easier to find and then keep specific celestial bodies in sight.

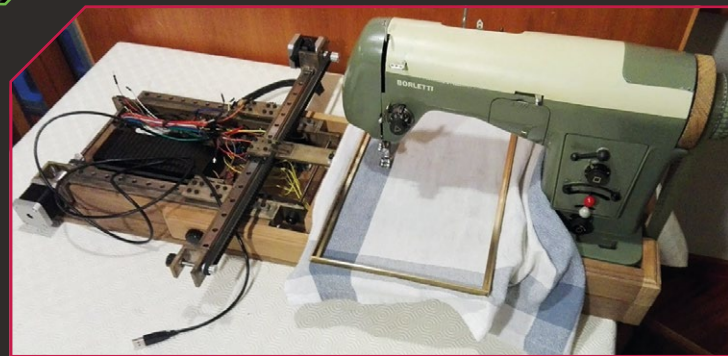

## CNC embroidery

Pi-powered embroidery

- Alessandro Benanti
- [magpi.cc/LpAyYu](http://magpi.cc/LpAyYu)

12

Automated embroidery machines that use a computer can cost a lot of money, so it's amazing that Alessandro managed to upcycle an old sewing machine to do the same job for less than £200. It's all automated and uses a Pi to control it all.

## Sisyphus Table

Beautiful robotic sand art

- Bruce Shapiro
- [magpi.cc/2fUUaRN](http://magpi.cc/2fUUaRN)

11

We love seeing amazing art projects that use the Raspberry Pi – this one is a beautiful coffee table that uses a robot to create Spirograph-esque patterns under the glass. You can even buy one yourself, if you have a few grand spare.



▲ Beneath the sand surface is a robot called Sisbot. This moves the ball using a powerful magnet



10



## Google Pi Intercom

Google AIY kit inside an old FM wireless intercom

► Martin Mander ► [magpi.cc/2vPQK6E](http://magpi.cc/2vPQK6E)

When Martin Mander saw *The MagPi* was giving away a free hardware voice kit from Google in issue 57, he did the sensible thing and rushed off to buy a copy. But after he assembled the components, placed them in the cardboard housing, and pressed the button to activate the Google Assistant to ask a question, he started to think about the future possibilities.

“The family and I enjoy the local car-boot sales and I’m always looking for old, obsolete, or broken technology that I can use in projects,” he says, relishing the chance of picking up something from the 1970s and 1980s.

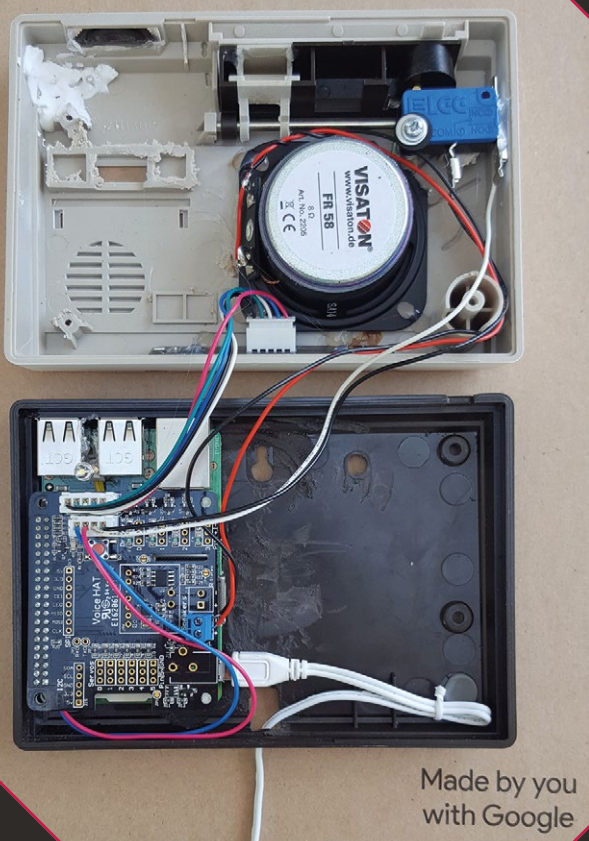

Made by you with Google

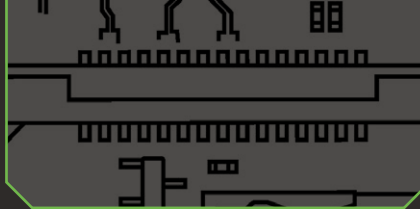

09

## Wizard Chess

A fully working Harry Potter Wizard’s Chess set

► Bethanie Fentiman ► [magpi.cc/dPjCUK](http://magpi.cc/dPjCUK)

Bethanie Fentiman can’t play chess, but when her imagination sparked and the opportunity presented itself, she brought the iconic game of Wizard’s Chess from Harry Potter to life using a Raspberry Pi, stepper motors, and possibly a little magic.

For her A-level computing coursework, Bethanie took an idea that had been nestling in the back of her mind, and turned it into a reality. Well, as much of a reality one can create when the literary version includes battling chess pieces that leave their opponents crushed to rubble on the board.



08

## Mesmeric Mirror

Fresh light on the idea of a motion-sensing illuminated mirror

► Roberto Tyley ► [magpi.cc/2wVeHNE](http://magpi.cc/2wVeHNE)

On reflection he could have just bought a lamp, but after Roberto Tyley stood on one too many of his children’s toys in the dark corners of his bedroom, he was hit by a flash of inspiration. What better way of illuminating the room, he mused, than a full-length portrait mirror

that would shine brightly whenever anyone wandered by? One with individually controllable LED lighting that would directly respond whenever someone posed in front of it, perhaps? As light-bulb moments go, he admits it was certainly high on the wacky scale.





## 3D Body Scanner

A relatively inexpensive full-body 3D scanner

➤ Poppy Mosbacher  
➤ [magpi.cc/2xRmUJR](http://magpi.cc/2xRmUJR)

07

While learning to make her own clothes, Poppy Mosbacher bought 27 Pi Zero Ws and 27 Camera Modules, 27 Pi Zero camera cables, and 27 USB to micro USB cables, as well as an assortment of battery packs, power regulators, wire connectors, and other electrical items. Inspired by Richard Garsthagen ([magpi.cc/2xVr3Vr](http://magpi.cc/2xVr3Vr)), Poppy then looked at making the scanner affordable and portable.

“It opens up new possibilities, such as of scans of children who won’t stay still long enough for the single camera method; building a personal database of scans taken at regular intervals to see the effects of aging; and making avatars for VR environments.”

When someone stands inside the frame, Take Photo is pressed on the laptop software, and the images are captured and saved

## Project MyHouse

06

This smart doll's house features gesture recognition

➤ Maks Surguy & Yi Fan Yin  
➤ [magpi.cc/sGPTSi](http://magpi.cc/sGPTSi)

Maks and Yi Fan conceived the idea of this interactive doll's house. Inside this cool crib, various features – including lighting and shutters – can all be turned on and off by the simple wave of a 'wand' (a PlayStation Move controller), with the help of some clever coding and a Raspberry Pi 3. You can see a demonstration video at [youtu.be/6EiTWZfPm3k](http://youtu.be/6EiTWZfPm3k).

“I thought a smart doll's house would be a great tool to demonstrate technical innovations to people in an approachable way,” says Maks, who worked with Yi Fan over a ten-week period, designing and constructing the clever little doll's domicile.



A Raspberry Pi 3 reads the gestures and controls all the electronic devices in the house



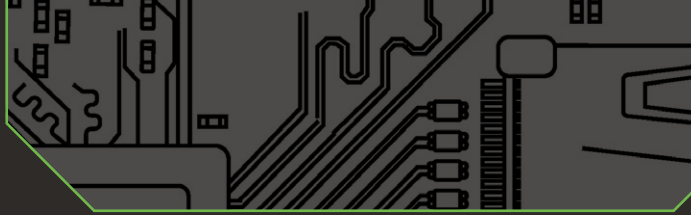

## Parts

- ▶ 7-inch display
- ▶ Poster frame
- ▶ Theme park memories

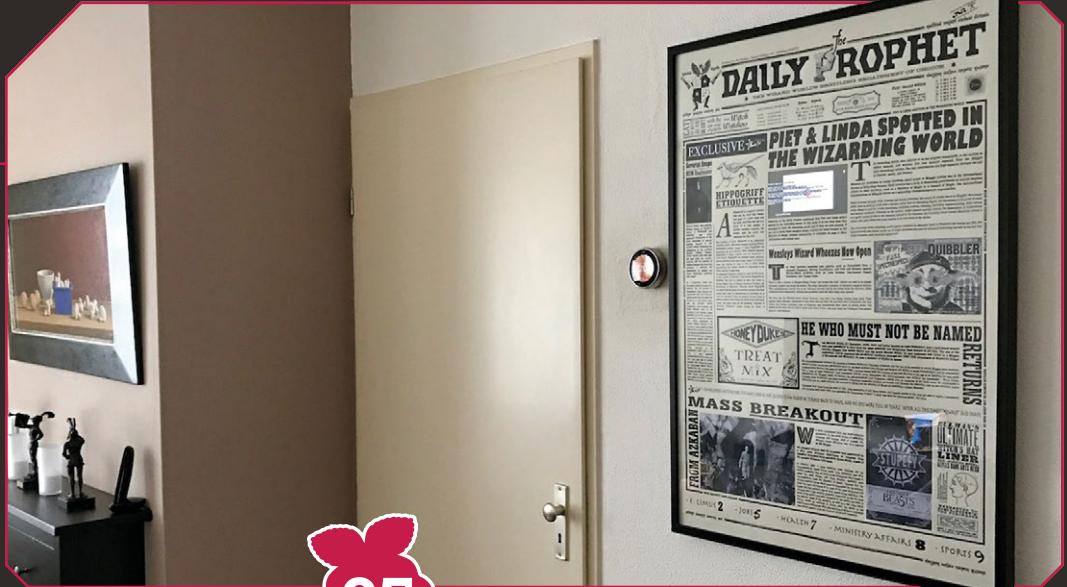

# Daily Prophet

Pi-powered magic newspaper

▶ Piet Rullens Jr ▶ [magpi.cc/MQJXKw](http://magpi.cc/MQJXKw)

Displaying holiday memories is something many of us think about. When Piet and Linda returned from the Wizarding World of Harry Potter, they had a lot of excellent video but nowhere to display it. Instead of getting one of those boring moving photo frames, Piet decided to take some inspiration from Harry Potter and

Instead of getting one of those boring moving photo frames, Piet decided to take some inspiration from Harry Potter

create their own Daily Prophet in their living room, complete with video display for authenticity.

“First, I designed the whole poster in Photoshop,” Piet tells us. “Within the design, I marked an area with the exact size of the Raspberry Pi screen. Next, I plotted the poster on normal paper at 100 percent, so the marked area still matched the Raspberry Pi screen.”

Piet was able to mount the frame over a small cupboard, making hiding the electronics easier. The videos have a sepia filter on them to fit in with the newspaper aesthetic, and a motion sensor waits for someone to come close to it before playing any video. A nice power-saving technique.

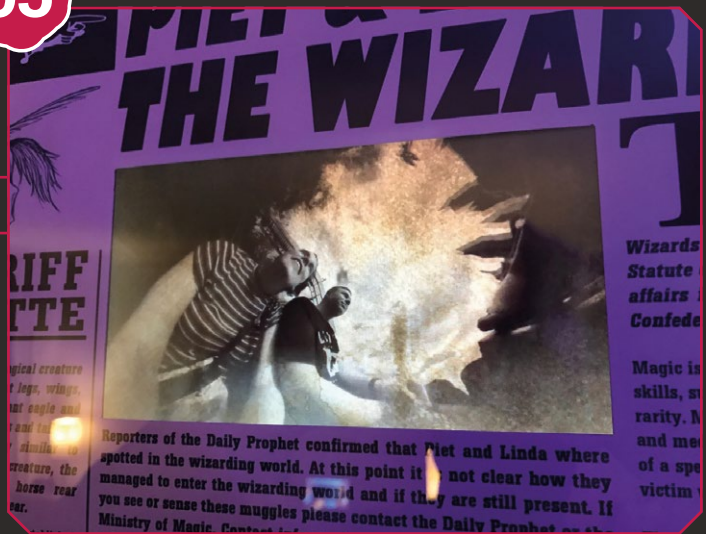

- ▲ It displays images and videos, much like its fictional counterpart
- ◀ The electronics are sneakily hidden behind the frame

Want to learn about using omxplayer to play videos?

Check out the documents on the GitHub: [magpi.cc/ABdFRJ](http://magpi.cc/ABdFRJ)

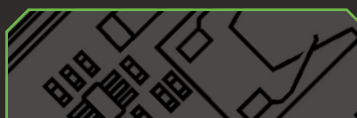



# PiOcket-Tiny Pi

A tiny gaming Pi

► Peter Barker ► [magpi.cc/CDXVIT](http://magpi.cc/CDXVIT)

People love to make very small things with the Pi Zero, and Peter is no different. After getting all the parts to upgrade an old Game Boy into a retro gaming powerhouse, he couldn't bring himself to take the working Game Boy apart and decided to make the smallest gaming Pi that he could.

"Things progressed from there, really," Peter explains. "I didn't like how big the circuit board was for the screen, and realised that there weren't all that many bits to it, so I started designing my own."

His resulting Game Boy Zero build led him to make an even smaller version: the Tiny Pi. It uses a 1.44-inch screen, a five-way joystick, and has two push-buttons. You can build one yourself with his available STL files, or using one of the kits he's now selling ([magpi.cc/byPFTG](http://magpi.cc/byPFTG)).

## Parts

- Custom PCB
- 1.44-inch display
- Pi Zero



### Make your own hand-held retro gaming device

using our guide in issue 55:  
[magpi.cc/55](http://magpi.cc/55)

▲ To get a true sense of its scale, here it is next to a classic Game Gear

► Peter designed custom PCBs for his project

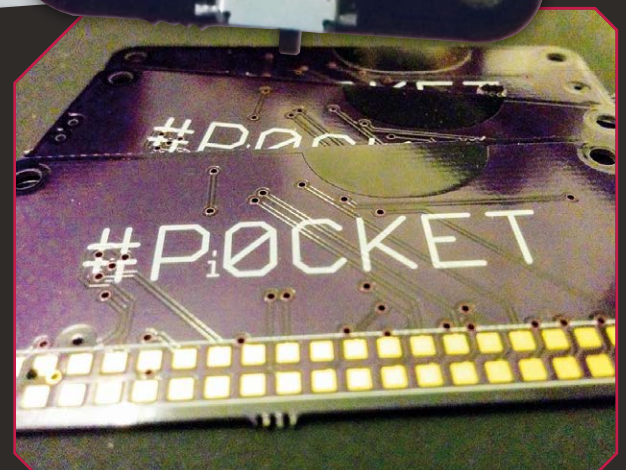
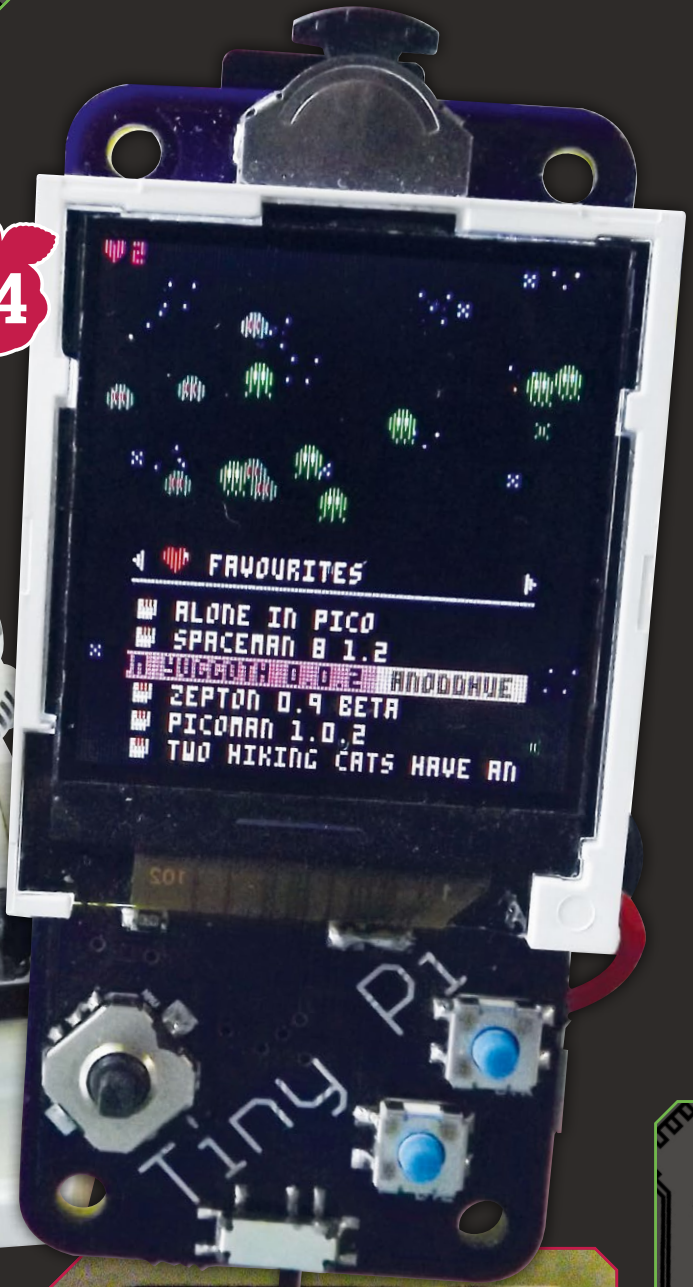





## Parts

- Raspberry Pi A+
- Adafruit 2.4-inch TFT touchscreen
- Adafruit Pi Protector case
- 1000 mAh lithium polymer battery
- Velcro wrist strap



# Windows 98 Watch

Wind back the clock with this chunky wristwatch

➤ Michael Darby ➤ [magpi.cc/eYtwCn](http://magpi.cc/eYtwCn)

“ Many years later you look back on it and want to relive it. I think time has a funny way of keeping more of the good than the bad within memory ”

▼ An AdaFruit 2.4-inch PiTFT touchscreen, with added push-buttons, is mounted on the Pi

If Microsoft had designed a smartwatch back in the late nineties, it might have looked something like this! Michael Darby, aka 314reactor, has built a chunky, Pi-powered wristwatch running the Windows 98 operating system.

While he admits the ancient OS used to drive him mad back in the day, he has an odd nostalgia for it. “Many years later you look back on it and want to relive it. I think time has a funny way of keeping more of the good than the bad within memory.”

Once he’d accrued the required components, including a Raspberry Pi Model A+, it only took a few hours to put together. He has since written a detailed build tutorial ([magpi.cc/yXfgmx](http://magpi.cc/yXfgmx)).

The watch is powered by a slimline LiPo battery connected via a PowerBoost 500 with switch, while Velcro feet secure the watch body to a wrist strap.

Michael has received plenty of positive feedback for his Windows 98 Watch, which he wore to Raspberry Pi’s Fifth Birthday Bash. “The reaction has been crazy; I never expected it to take off like it did, but I’m very happy it did and it has inspired me to create more and work harder.”

You can learn all about Windows 10 IoT Core in issue 48: [magpi.cc/48](http://magpi.cc/48)





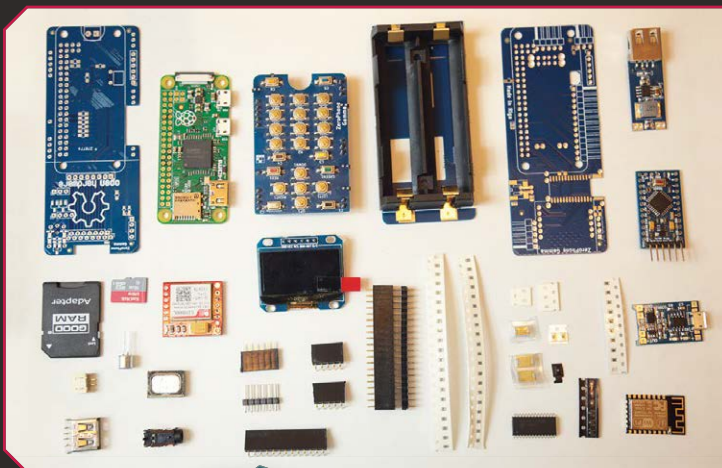
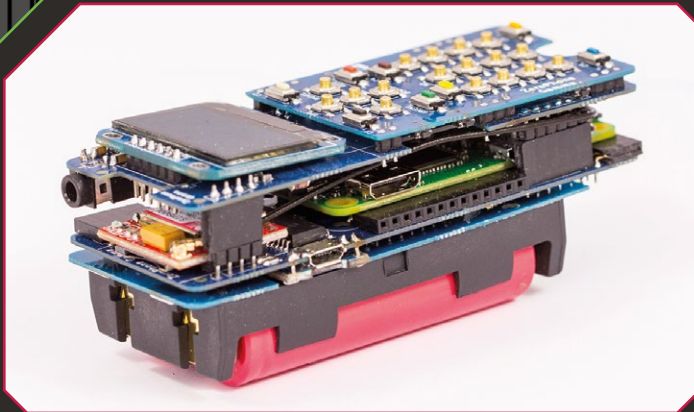

▲ Fancy assembling your own smartphone? You'll soon be able to buy a ZeroPhone kit

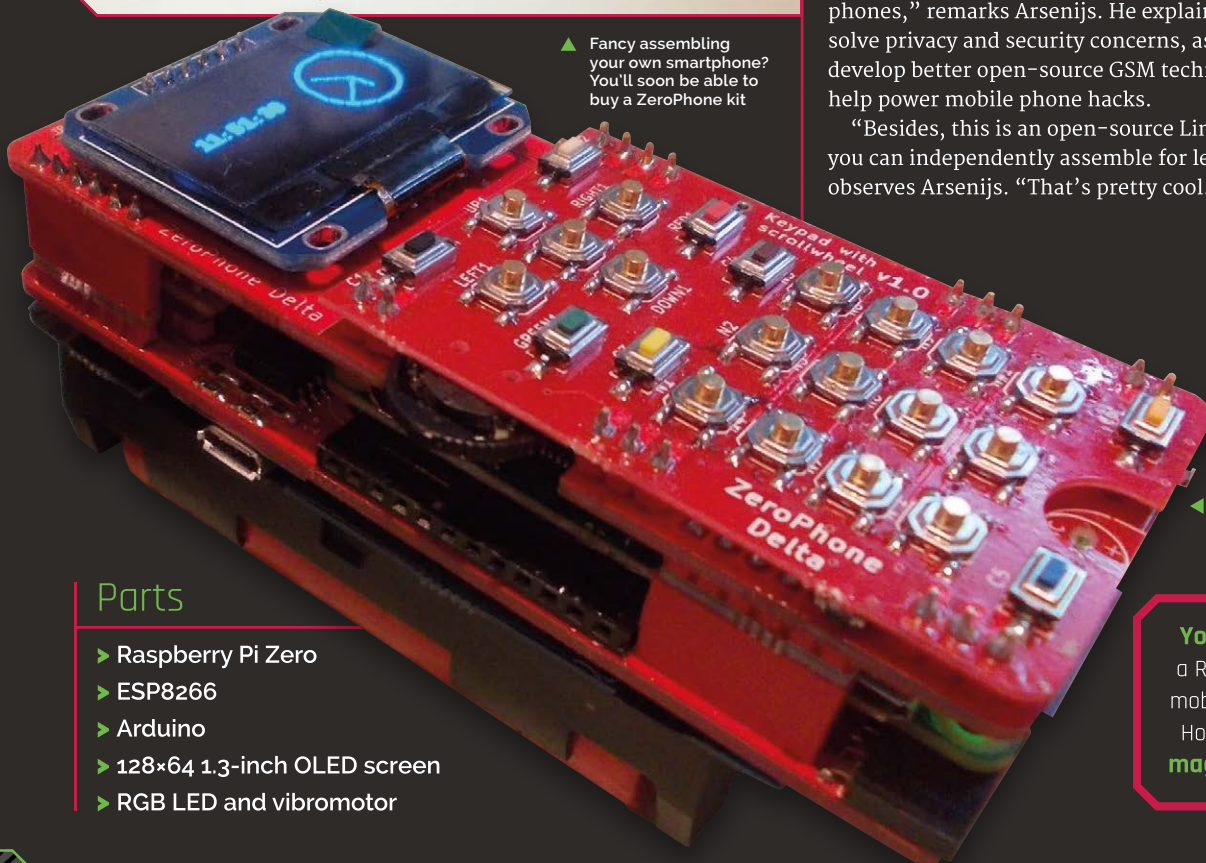

# Zero Phone

Turning a Pi Zero into a mobile phone

► Arsenijs Pičugins ► [magpi.cc/XAMjks](http://magpi.cc/XAMjks)

ZeroPhone is an open-source project to create a mobile phone kit for the Pi Zero. Owners of ZeroPhone will be able to make calls and send text messages. It will also have basic apps such as an alarm clock, calendar, calculator, web browser, and music player.

Behind the project is Arsenijs Piugins, an 18-year-old student from Riga, Latvia. He now has a team of people helping him.

The open-source software approach is “likely to be secure and not privacy-invading,” says Arsenijs. You can disable features you don’t like, and it doesn’t depend on any cloud services. You will be able to install firewall, I2P, and TOR nodes, as well as secure messenger services.

“It’s open-source, Linux-powered, and you can make one yourself for \$50,” he says. Since the project first appeared in *The MagPi*, Arsenijs has taken the project to Crowd Supply for funding.

“For me, this project is a huge undertaking that, if done right, will influence the way we perceive mobile phones,” remarks Arsenijs. He explains that it will help solve privacy and security concerns, as well as allow us to develop better open-source GSM technology. It will also help power mobile phone hacks.

“Besides, this is an open-source Linux-powered phone you can independently assemble for less than \$50,” observes Arsenijs. “That’s pretty cool.”



▲ A SIM800 GPS module and antenna are used to connect to the mobile phone network

## Parts

- Raspberry Pi Zero
- ESP8266
- Arduino
- 128×64 1.3-inch OLED screen
- RGB LED and vibromotor

**You can connect** a Raspberry Pi to a mobile network with Holgram.io's Nova: [magpi.cc/WXGKxH](http://magpi.cc/WXGKxH)

WINNER!

# PiSwitch

Retro gaming with a modern twist

► Christopher Foote ► [magpi.cc/epZyLp](http://magpi.cc/epZyLp)

**W**hen the Nintendo Switch was first released, it seemed like it would be an inevitability for someone to replicate the form factor and controller functions to make a Pi-powered retro console. Within a few months, Christopher Foote had managed to do it. However, it wasn't quite as easy as 3D-printing a few controller connectors.

Surprisingly, the Linux Joystick Mapper worked with the Joy-Cons – the detachable controllers on each side of the Switch. However, there was one problem, as

“I can play one-player with both controllers to fully emulate a Nintendo 64 or PlayStation”

Christopher recalls: “It worked great apart from the analogue sticks, so I looked through the code for a few hours, figured how Linux Joystick Mapper worked, and reprogrammed it for Joy-Con compatibility.”

## Custom case

That was the first step to getting the entire setup working. Next was the case and assembling the hardware, using a 7-inch touchscreen display, an extended headphone jack, built-in speakers, and a custom 3D-printed case. The real trick to the case is that the Joy-Cons can slot into it, much like the real thing.

“I took my Switch and a pair of digital calipers and I measured the inserts for the controllers,” Christopher says. “I can play one-player with both controllers to fully emulate a Nintendo 64 or PlayStation controller... The Joy-Cons also load different controller maps.”

## More than games

It's an amazing feat, and it doesn't just run RetroPie either: you can also watch stuff via Kodi, and Christopher is trying to figure out Steam streaming as well.

We think it's great, and apparently so did the folks in the community, as you have voted it to be the most amazing Raspberry Pi project of the last two-or-so years! We wonder what amazing projects we'll see over the next two. **M**

The Joy-Cons are used to control the games. After much struggle, Christopher managed to get the analogue sticks working



## Parts

- Joy-Con controllers
- 7-inch touchscreen
- A big battery

The Joy-Cons can be used for two-player gaming

▼ A Pi Camera Module is included in the build – please ignore the messy 3D print, though

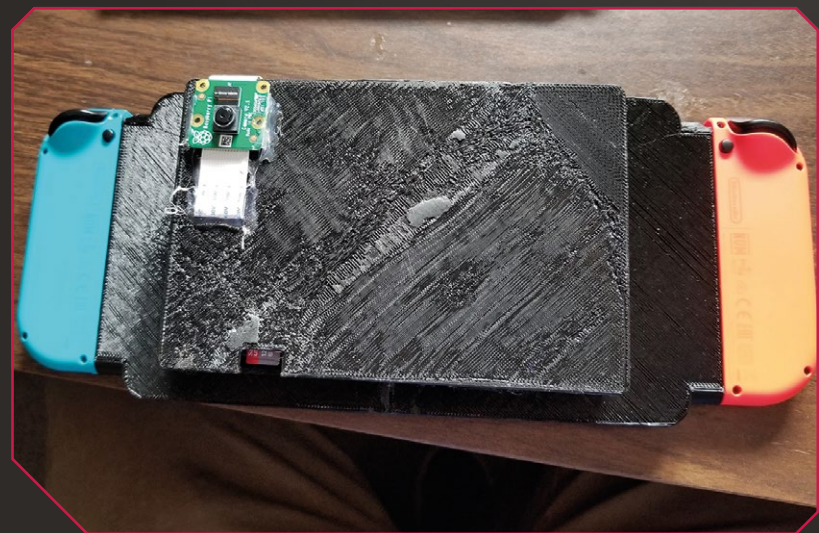



Linux can support a lot of game controllers by default

The 3D-printed case holds the Pi 3 and other components and it includes the locking mechanism for the Joy-Con controllers



The 7-inch Raspberry Pi Touch Display is at the heart of the project, which also makes use of RetroPie for emulation

▼ Using digital callipers, Christopher was able to replicate the Switch's detachable controller function

▼ The touchscreen aspects are also replicated from the Switch



PiSwitch can also be plugged into a TV



# SUBSCRIBE TODAY FROM ONLY £5

SAVE  
UP TO **35%**

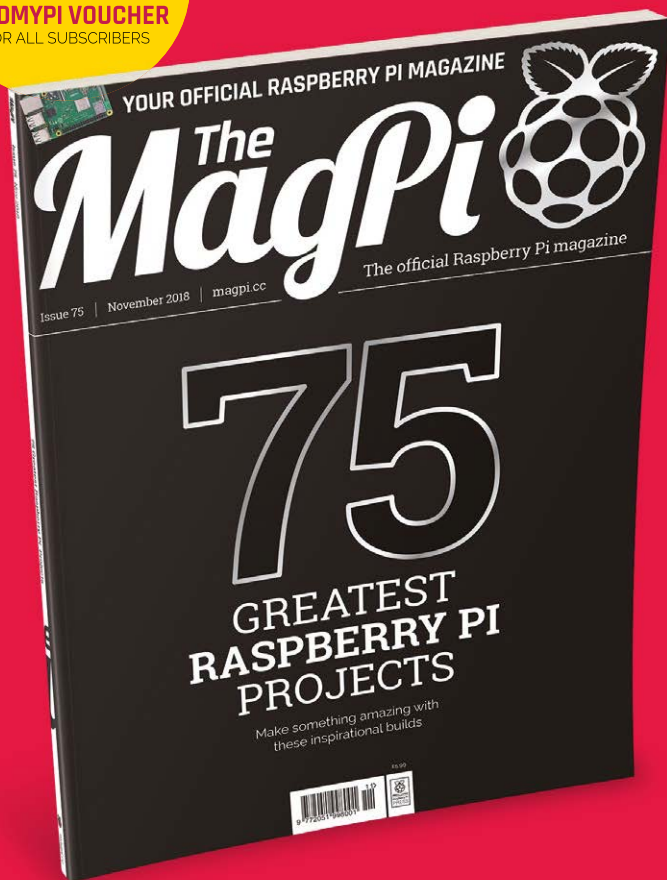

## Subscriber Benefits

- ▶ **FREE Delivery**  
Get it fast and for FREE
- ▶ **Exclusive Offers**  
Great gifts, offers, and discounts
- ▶ **Great Savings**  
Save up to 35% compared to stores

## Rolling Monthly Subscription

- ▶ **Low Monthly Cost** (from £5)
- ▶ **Cancel at any time**
- ▶ **Free delivery to your door**
- ▶ **Available worldwide**

## Subscribe for 12 Months

£55 (UK)      £90 (USA)  
£80 (EU)      £95 (Rest of World)

Free Pi Zero W Kit with 12 Month upfront subscription  
only (no Pi Zero Kit with Rolling Monthly Subscription)



Subscribe online: [magpi.cc/subscribe](https://magpi.cc/subscribe)



JOIN FOR 12 MONTHS AND GET A  
**FREE Pi Zero W Starter Kit**  
 WITH YOUR SUBSCRIPTION

Subscribe in print for 12 Months today and you'll receive:

- ▶ Pi Zero W
- ▶ Pi Zero W case with three covers
- ▶ USB and HDMI converter cables
- ▶ Camera Module connector

Offer subject to change or withdrawal at any time

**WORTH £20**

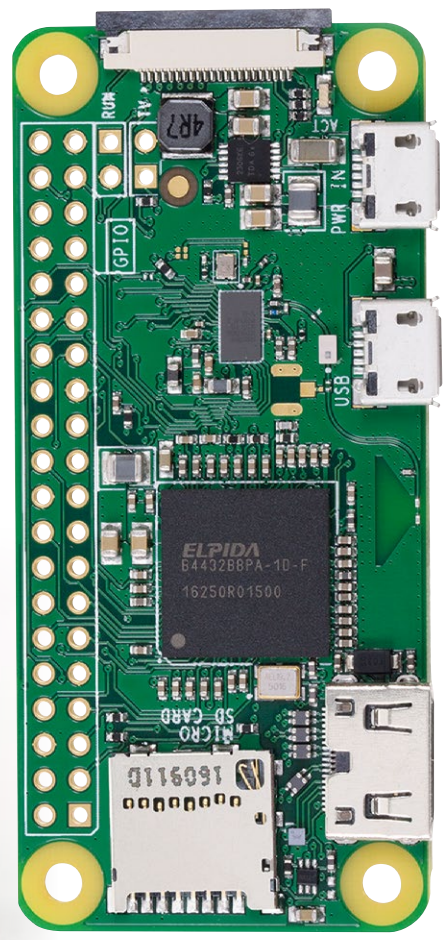

 Buy now: [magpi.cc/subscribe](http://magpi.cc/subscribe)

**SUBSCRIBE**  
 on app stores  
 From **£2.29**





**Phil King**

When not subbing *The MagPi* and editing Raspberry Pi books, Phil enjoys watching a mixture of quality (*Endeavour*, *The Crown*) and other (old *Dynasty* re-runs) TV.

[magpi.cc](http://magpi.cc)

**You'll Need**

- > Raspberry Pi TV HAT
- > Wireless network
- > Computer

# Watch live TV from your Pi with the TV HAT

Set up your new add-on to stream live TV from and to a Raspberry Pi

The latest official Raspberry Pi add-on is a must for telly addicts. The Raspberry Pi TV HAT enables any Raspberry Pi (with 40-pin GPIO) to decode live digital TV signals and stream them to remote devices – such as another Pi, computer, or even a smartphone. The HAT's built-in Sony CXD2880 tuner supports DVB-T2 and DVB-T standards (Freeview in the UK), so you can watch all your favourite channels. Here we show you how to set it up, and even use it to turn a Pi into an all-in-one TV/PVR.

**01 Assemble and mount**

Insert the thin end of the supplied silver RF cable adapter into the gold connector on the side of the HAT. Take the supplied 40-pin header and insert its pins into the holes in the underside of the HAT – not into the black female header on the top! Mount the HAT on the Pi, with the RF adapter at the microSD card slot end. To make it secure, you can screw it in using the supplied stand-offs.

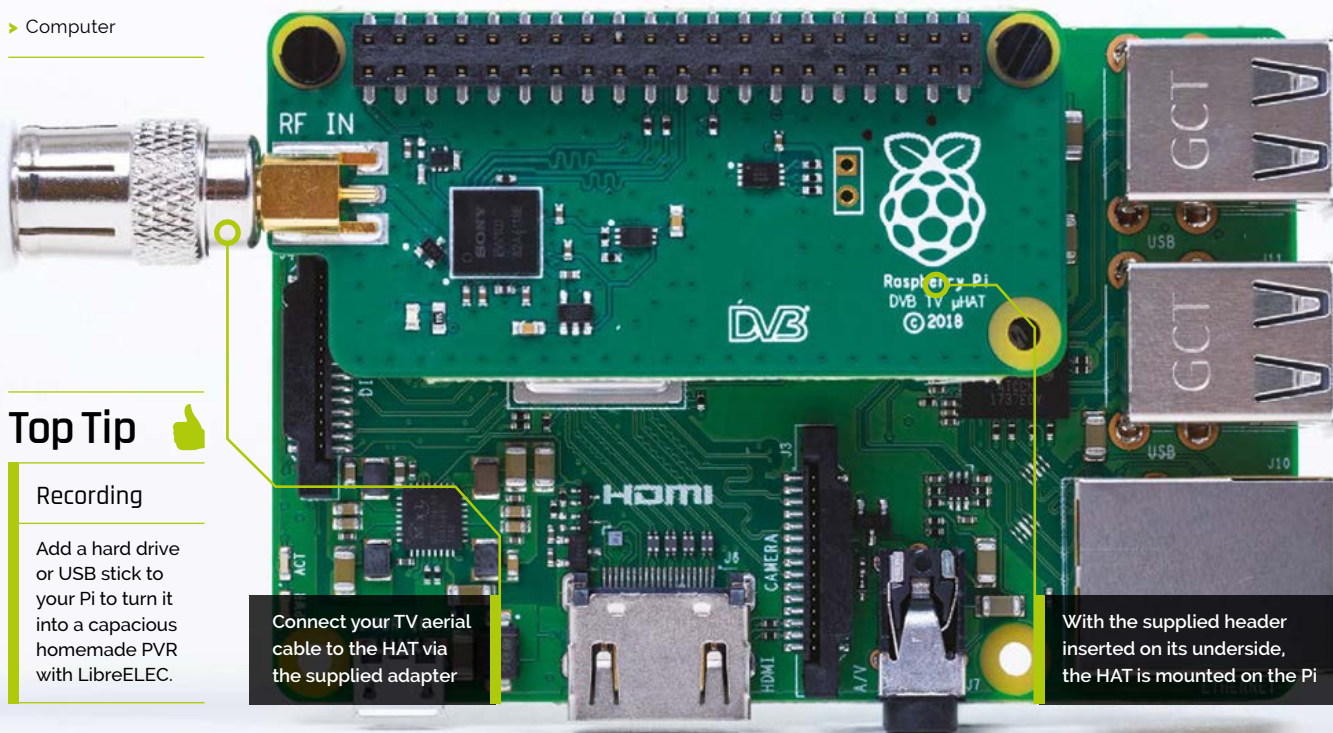

**Top Tip**

**Recording**

Add a hard drive or USB stick to your Pi to turn it into a capacious homemade PVR with LibreELEC.



## 02 Install Tvheadend

Connect a coaxial RF cable from a TV aerial socket to the RF adapter on the HAT. You'll need decent digital terrestrial TV (Freeview in the UK) reception for the tuner to work. With Raspbian Stretch installed on its microSD card, turn on the Raspberry Pi – a green LED will light on the HAT.

We need to install a back-end TV service to stream video: we'll use Tvheadend. To install it, open a Terminal window and enter:

```
sudo apt-get update
sudo apt-get install tvheadend
```

## 03 Configure Tvheadend

It takes a few minutes for Tvheadend to install, so you may want to go and make a cup of tea. Once installed, a package configuration screen will appear and you'll be prompted to enter a Tvheadend administrator user name. For simplicity's sake, enter **kodi** for this, then also enter **kodi** for the password – you can always change it later if you prefer. You're now ready to log in from another device.

## 04 Log in remotely

Now that Tvheadend is running, you can access it from another computer (possibly a second Raspberry Pi). In a web browser, enter this address: <http://raspberrypi.local:9981/extjs.html>. If that doesn't resolve, use the Pi's IP address instead, followed by [:9981/extjs.html](http://9981/extjs.html). Log in using **kodi** for both the user name and password. A configuration wizard will appear, enabling you to choose the TV network type and transmitter.

## 05 Configure TV network

In the configuration wizard's 'Network settings', it should show 'Tuner: Sony CDX2880 #0 DVB-T #0'. For the Network Type, choose 'DVB-T Network'. For predefined muxes, select your local transmitter: for example, ours was uk-Rowridge. Upon clicking Save & Next, it'll start scanning for muxes and services (channels). After it reaches 100%, tick all three boxes (Map all services, Create provider tags, Create network tags) and an electronic programme guide (EPG) will appear.

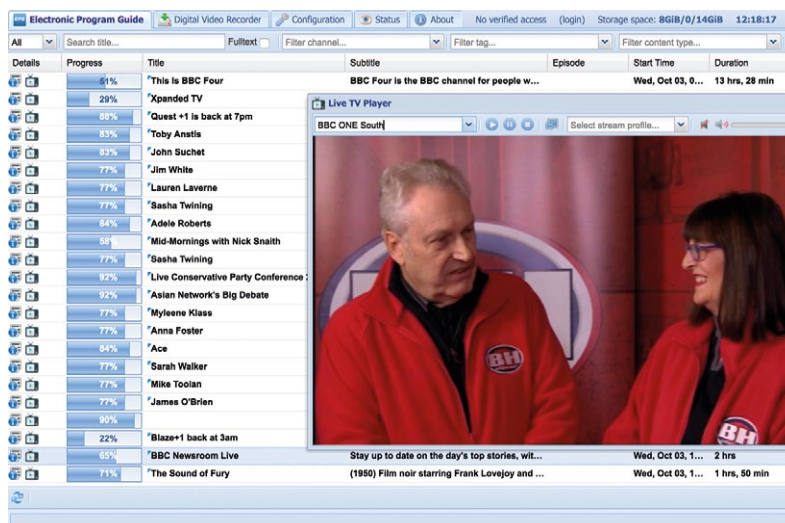

## 06 Watching TV

You can now watch live TV streamed from the TV HAT in your browser. In the EPG, click the TV icon to the left of any programme to show it in a window, which you can expand to full-screen. There are also options to schedule and record shows – use the Help option for more details.

As well as using a web browser, you can view the TV stream from a variety of clients, including Kodi, omxplayer, VLC, and smartphone apps – see [magpi.cc/Zpjtwd](http://magpi.cc/Zpjtwd).

▲ You can access the EPG and watch live TV in a web browser on a remote computer

## Using LibreELEC

The live TV stream from the TV HAT can be accessed in the Kodi media player, most easily by using the LibreELEC OS on a Raspberry Pi. Install the Tvheadend client by selecting Add-ons > Install from repository > PVR clients > Tvheadend HTSP Client.

In addition, using LibreELEC, it's possible to set up both the Tvheadend client and server on the same Raspberry Pi – a Pi 2, 3, or 3B+ is recommended – for an all-in-one TV/PVR device. To do so, select Add-ons > Install from repository > Services > Tvheadend Server 4.2, and install it. Access it from another computer using the IP address followed by [:9981](http://9981) and set it up as in Step 5. You can then access it from within LibreELEC (with the Tvheadend client installed) by selecting the main 'TV' option.

To make TV recordings, you'll need to create a **recordings** folder on a connected USB stick or hard drive – navigate to it in File Manager, right-click, and select 'Make new folder'. Then, in the web interface on a remote computer, go to Configuration > Recordings and set the recording system path to `var/media/[your_drive_name]/recordings`.

## Top Tip

### Live viewing

The live TV stream can be accessed in many ways, including Android and iOS apps.

# Build a secret radio chat device



**PJ Evans**

PJ is a writer, developer, and runs the Milton Keynes Jam. He is worryingly passionate about switching things on and off.

[mrpjevans.com](http://mrpjevans.com)

Add a cheap 433MHz radio to your Raspberry Pi to send wireless messages without WiFi and operate remote-control main sockets

**S**ure, WiFi is all well and good, but is it the only option for wireless communication on the Raspberry Pi? What if there isn't a network available or you need a longer range? 433MHz radio is where you want to be. In this tutorial we'll add this capability to a pair of Pi boards and show how to send wireless messages from one to the other with no WiFi network. Then, we'll increase the range with a touch of science and start talking to RF-based switchable main sockets. Have Pi-controlled sockets all around the house!

got access to multiple monitors and keyboards, consider using SSH to access each Pi with two windows on your main computer. That way you can see everything taking place.

## 01 Prepare your Pi boards

To demonstrate sending messages using 433MHz, it makes sense to use two Raspberry Pi boards so we can have a conversation. None of what we're doing here requires much processing power, so any Pi will do, even original Model As or Bs. Depending on what you're comfortable with, install either full Raspbian Stretch, or – as we're doing here – Raspbian Lite, as everything will be run from the command line. If you haven't

## 02 Meet the transceivers

Each kit comes with two circuit boards. The longer of the two boards is the receiver, sporting four pins. Before wiring up, check the labelling of these pins very carefully as they do sometimes vary. Regardless of position, there will be 5V power in (labelled VCC), ground (GND), and two 'DATA' lines which transmit the received signals. These are identical so you can use either.

The smaller transmitter has three lines, which again can vary in position based on the manufacturer. Just like the receiver, you have VCC for power, GND for ground, and this time, a single data line.

## 03 Wire-up the breadboard

We're using a tiny breadboard, but any size will work. In fact, a larger board with power and ground rails might be a bit tidier. Carefully insert a receiver and transmitter in each breadboard opposite each other. We want the two breadboards opposite so that the transmitter of Pi #1 (which we're calling 'Alice') is pointing directly at the receiver of Pi #2 ('Bob') and vice versa.

Connect six jumper leads to each breadboard, one on the rail for each pin of the transceiver pair. It doesn't matter which 'DATA' line you use on the receiver.

### You'll Need

- ▶ 2 × 433MHz transceivers [magpi.cc/yXnbtu](http://magpi.cc/yXnbtu)
  - ▶ 2 × Mini breadboards [magpi.cc/QEyLck](http://magpi.cc/QEyLck)
  - ▶ 12 × M/F jumper leads [magpi.cc/UgGBxg](http://magpi.cc/UgGBxg)
  - ▶ RF mains socket kit [magpi.cc/vuCjwL](http://magpi.cc/vuCjwL)
- ▶ Here's everything you need. It is possible to just use one Raspberry Pi, but double up for more fun

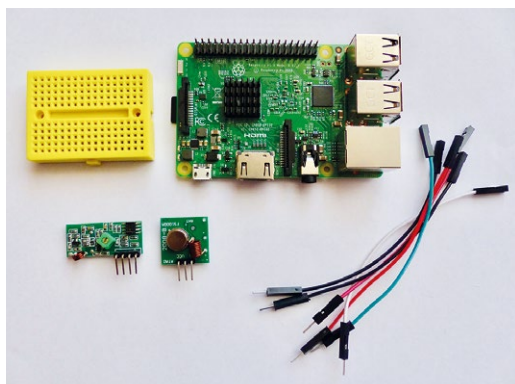



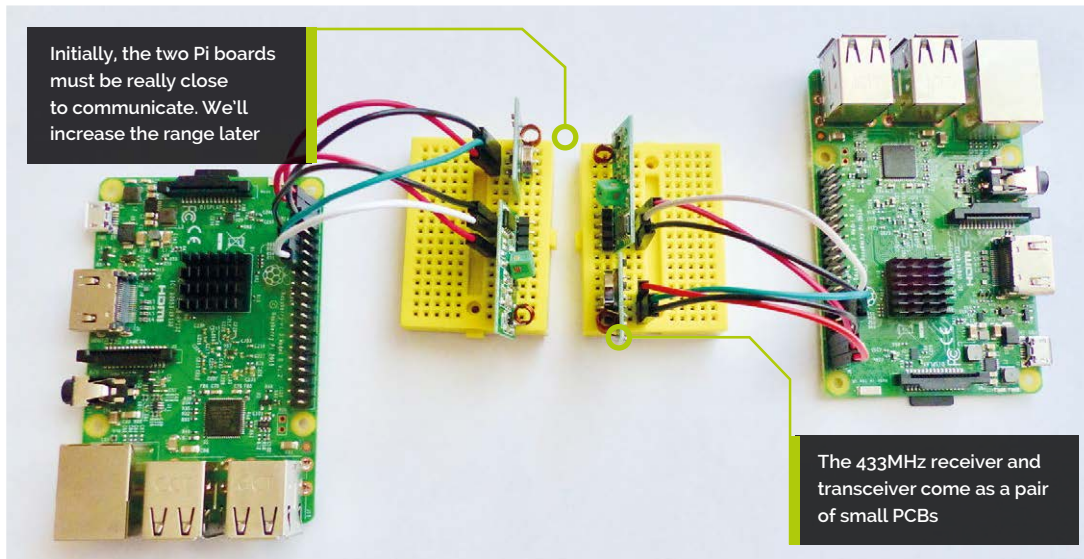

## 04 Connect to the Pi boards

Connect each Pi to its six jumper leads. Luckily, this project doesn't require any additional components, so you can wire directly. Both the receiver and transmitter run at 5V, so connect each VCC jumper lead to physical pins 2 and 4 of the GPIO (the top two right-hand pins when pin 1 is top-left). Next, connect the GND leads to pins 6 and 9. Although your radio is now powered, it's not much use if it can't send and receive data, so connect the transmitter's DATA to GPIO17 and the receiver's DATA to GPIO27 (pins 11 and 13).

## 05 Test receive

Before we can do anything with our newly installed radio, we need some software. Open up a Terminal and issue the following commands:

```
cd
sudo apt install python3-pip git
pip3 install rpi-rf
git clone https://github.com/mrpjevans/rfchat.git
```

You now have everything installed to test your hardware. Pick your favourite of the two Raspberry Pi boards and enter the following:

```
cd ~/rfchat
python3 receive.py
```

Now hold the remote control from the RF kit very close to the receiver and press its buttons. See numbers appear? Great. If not, review your wiring. Press **CTRL+C** to quit and repeat on the other Pi.

## 06 Test send

Position the Raspberry Pi boards so the two breadboards are within a centimetre of each other, with Alice's transmitter pointing at Bob's receiver and likewise the other way around. On Alice, start the receive script just as we did in the previous step. On Bob, enter the following in the Terminal:

```
cd ~/rfchat
python3 send.py 1234
```

All being well, '1234' should be displayed repeatedly on Alice's screen. There's no error correction, so it's normal to see missing or corrupt characters. If it doesn't look quite right, try again. Once you're happy, reverse the test to confirm Bob's receiver is also working.

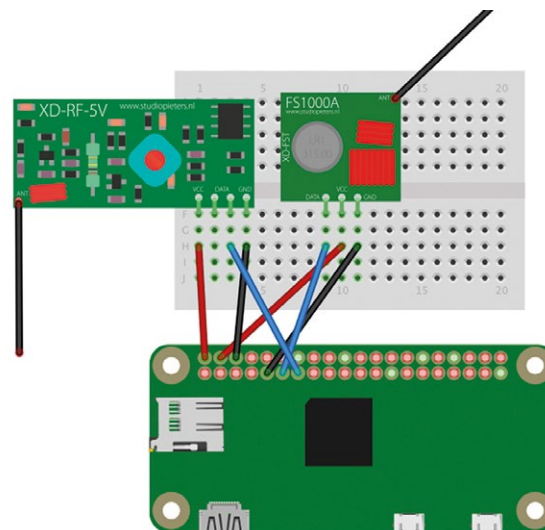

◀ The pair of transceivers do not require any additional components and can be wired straight to the GPIO

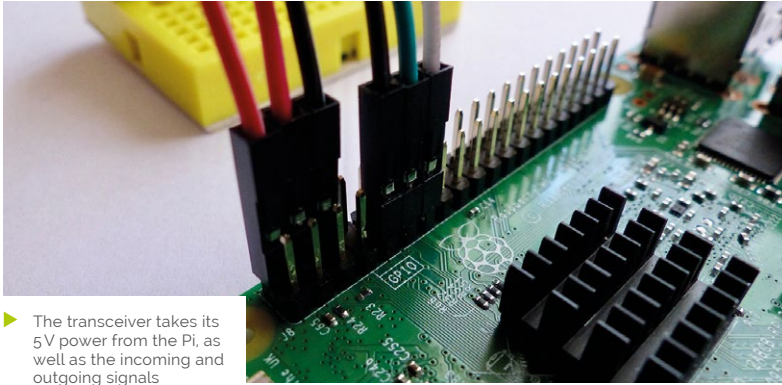

► The transceiver takes its 5V power from the Pi, as well as the incoming and outgoing signals

## 07 Let's have a chat

Our two Raspberry Pi boards can now communicate wirelessly without WiFi. To demonstrate what's possible, take a look at the `rfchat.py` script. This code uses threading (code-speak for doing multiple things at once) to monitor the keyboard and receiver for data. We convert incoming and outgoing data to numbers (ASCII) and back. The result is a live chat interface. You can now send and receive messages. To start:

```
cd ~/rfchat
python3 rfchat.py
```

Now slowly type on either Pi and the message will appear on the other. In fact, your local output is your receiver picking up your own transmitter!

## 08 Increasing range with science

The reason for the radio's poor range is the tiny antennas, but this can be fixed. The antenna's length needs to be a harmonic of the wavelength, which is calculated by dividing the speed of light by the frequency (299 792 458 m/s divided by 433 000 000). You can keep dividing the result of 692.36 mm by 2 until you get a sensible length. A 173 mm antenna is long enough to give an impressive range, normally covering a whole house. Solder 173 mm wires to all four 'ANT' solder points on the PCBs. Your `rfchat` should now work over long distances.

## 09 Socket to me

There are many household devices that use 433MHz to send control codes. Among the most popular are remote-control mains sockets,

# rfchat.py

► Language: **Python 3**

```
001. import sys
002. import tty
003. import termios
004. import threading
005. import time
006. from rpi_rf import RFDevice
007.
008. # Elegant shutdown
009. def exithandler():
010.     termios.tcsetattr(sys.stdin, termios.
    TCSADRAIN, old_settings)
011.     try:
012.         rx.cleanup()
013.         tx.cleanup()
014.     except:
015.         pass
016.     sys.exit(0)
017.
018. # Activate our transmitter and received
019. tx = RFDevice(17)
020. tx.enable_tx()
021. rx = RFDevice(27)
022. rx.enable_rx()
023.
024. # Receiving loop
025. def rec(rx):
026.
027.     print("Receiving")
028.
029.     lastTime = None
030.     while True:
031.         currentTime = rx.rx_code_timestamp
032.         if (
033.             currentTime != lastTime and
034.             (lastTime is None or currentTime -
lastTime > 350000)
035.         ):
036.             lastTime = rx.rx_code_timestamp
```



often used to switch lights. These commonly use 433MHz and protocols that rpi-rf can understand.

```
cd ~/rfchat
python3 receive.py
```

Press buttons on the remote control. You're likely to see a list of numbers, repeating for error correction, that change with each button. Make a note of these and then send them out as follows:

```
python3 send.py [number]
```

You should hear a reassuring 'click' from the relay of the socket. Try switching it on or off.

## 10 Make it your own

These 433MHz units add a range of possibilities to your Raspberry Pi projects at a very low cost. Not just home automation projects with controllable sockets, but also providing radio communication where WiFi isn't practical, such as high-altitude ballooning or unusually positioned sensors like flood monitors. IoT devices can use

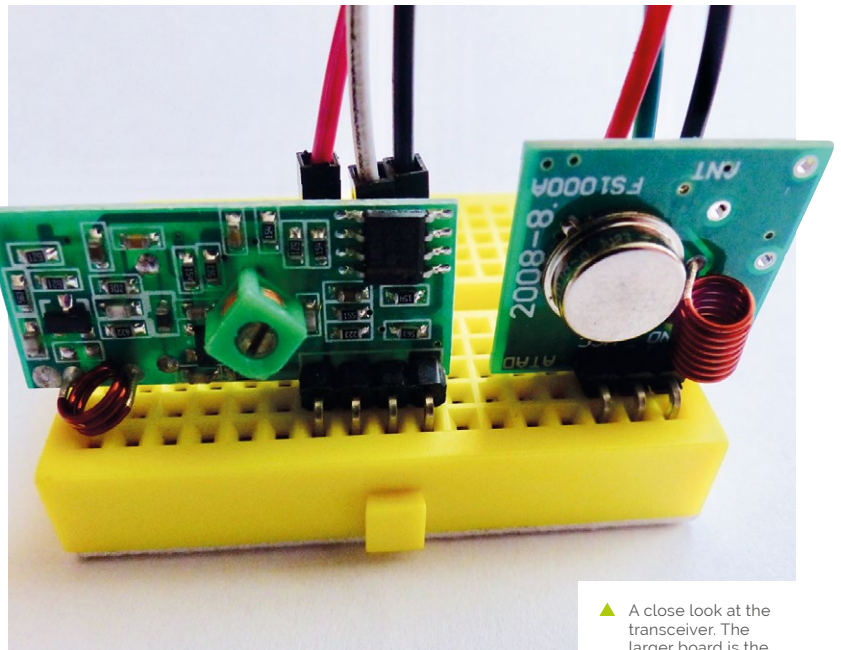

▲ A close look at the transceiver. The larger board is the receiver and the smaller square board transmits

radio to deliver and receive any information. Now you can control sockets from your Raspberry Pi, you can link these up to any kind of event you can imagine. How about detecting your car coming home using a Pi Camera Module and number-plate recognition, then switching on the house lights? [📖](#)

**DOWNLOAD  
THE FULL CODE:**



[magpi.cc/mcxmKh](https://magpi.cc/mcxmKh)

```
037.         try:
038.             if (rx.rx_code == 13):
039.                 # Enter/Return Pressed
040.                 sys.stdout.write('\r\n')
041.             else:
042.                 sys.stdout.write(chr
043. (rx.rx_code))
044.                 sys.stdout.flush()
045.             except:
046.                 pass
047.
048.             time.sleep(0.01)
049.
050. # Start receiving thread
051. t = threading.Thread(target=rec,
052.                      args=(rx,), daemon=True)
053. t.start()
054. print("Ready to transmit")
```

```
055.
056. # Remember how the shell was set up so we can reset
057. # on exit
058. old_settings = termios.tcgetattr(sys.stdin)
059. tty.setraw(sys.stdin)
060.
061. while True:
062.     # Wait for a keypress
063.     char = sys.stdin.read(1)
064.
065.     # If CTRL-C, shutdown
066.     if ord(char) == 3:
067.         exithandler()
068.     else:
069.         # Transmit character
070.         tx.tx_code(ord(char))
071.
072.     time.sleep(0.01)
```

# Pi Bakery: The Matrix



**Mike Cook**

Veteran magazine author from the old days, writer of the Body Build series, plus co-author of *Raspberry Pi for Dummies*, *Raspberry Pi Projects*, and *Raspberry Pi Projects for Dummies*.

[magpi.cc/259aT3X](http://magpi.cc/259aT3X)

The Matrix is an undedicated array of switches and lights that can be put to any number of uses - this month, let's do the final assembly

Last month we completed the construction of the controller board. Now we see how to bring all the parts we have built so far together and see the basic functions come to life.

## 01 Wiring up the LED boards

We need to take the LED boards and add some wires so we can connect them to the controller board (Figure 1). While electricity doesn't care what colour wires it flows through, it helps us enormously to connect them up to the

right place. We used violet, blue, green, red, and orange wire for this (as shown in Figure 12 in the first part of this tutorial, issue 73). That is orange for the cathode, red for the red LED A0, green for the green LED A1, blue for the blue LED A3, and finally violet for the switch pin SW.

## 02 Getting the wires the right length

We soldered one end of the wires to each wire reel and gathered the wires together (Figure 2). Then we pulled out a sufficient quantity of wire to reach the controller board from one of the matrix positions and snipped off all the wires. Remember that wires need to reach both sides of the controller board, so it's better to make the wires too long rather than too short. Next, we took a battery tray and put a temporary sticky label on it with the matrix position number written on it, and finally passed the wires through the side slot. We repeated this for all matrix positions.

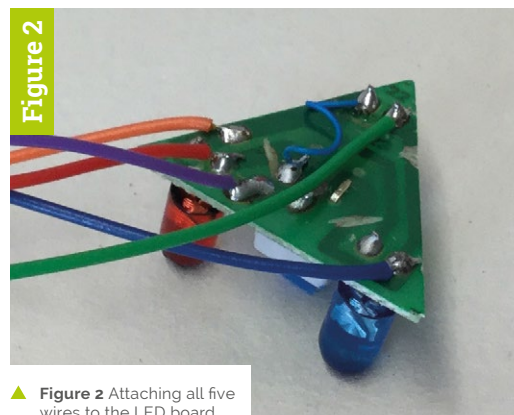

▲ Figure 2 Attaching all five wires to the LED board



**Figure 1**

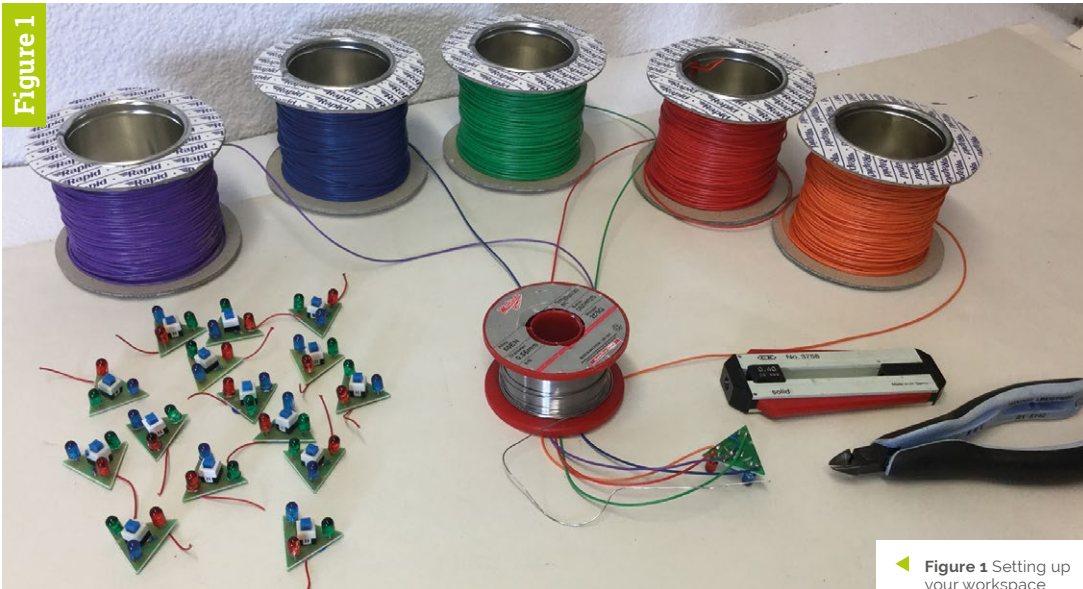

◀ **Figure 1** Setting up your workspace

**You'll Need**

- ▶ 2 × 40-way IDC connectors  
[magpi.cc/MLBnKF](http://magpi.cc/MLBnKF)
- ▶ 600 mm of 40-way ribbon cable  
[magpi.cc/ysjGdR](http://magpi.cc/ysjGdR)
- ▶ Red, green, blue, orange, and violet wire  
[magpi.cc/QNcPdI](http://magpi.cc/QNcPdI)

▼ **Figure 3** The schematic of the matrix made from LED boards

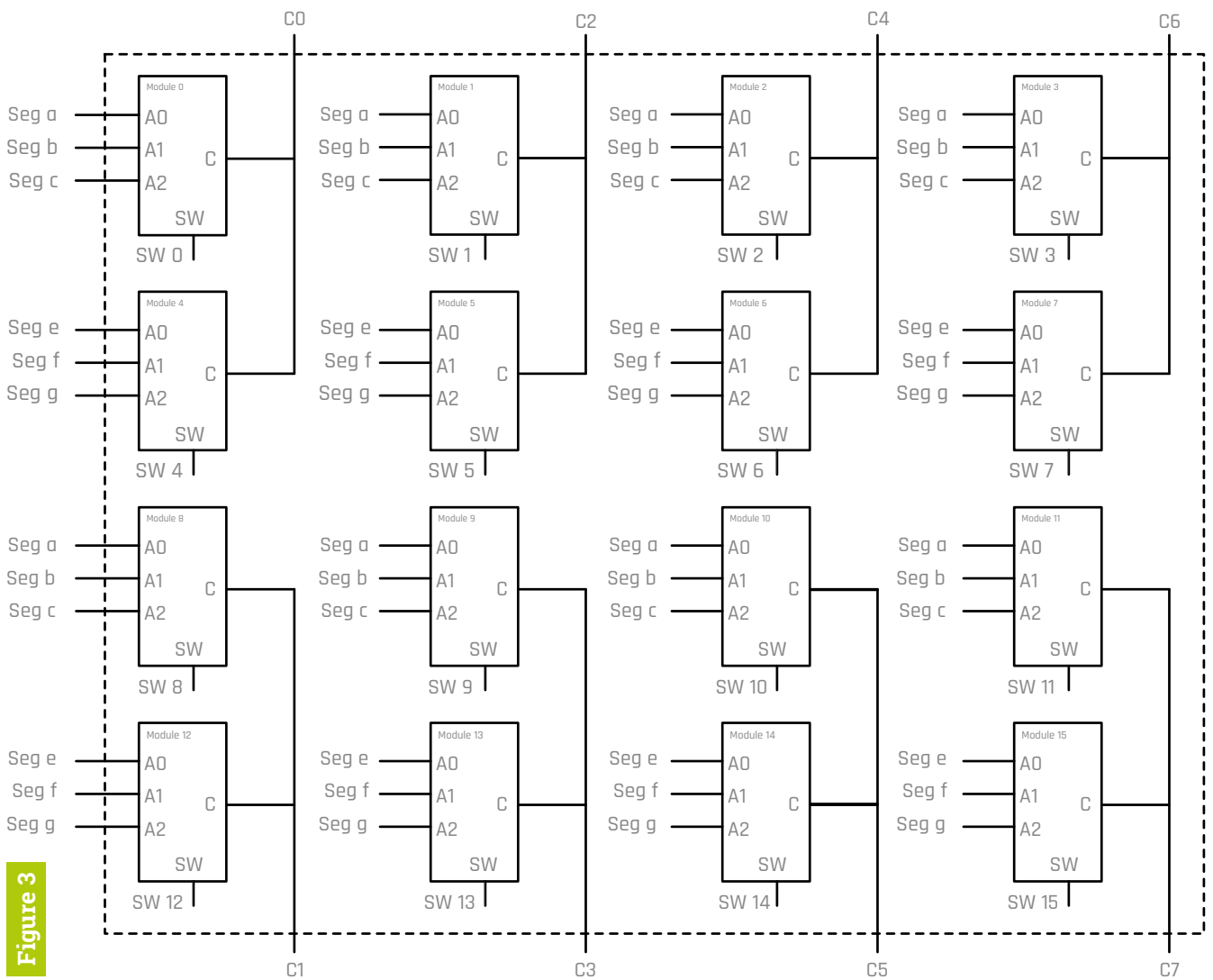

**Figure 3**

Figure 4

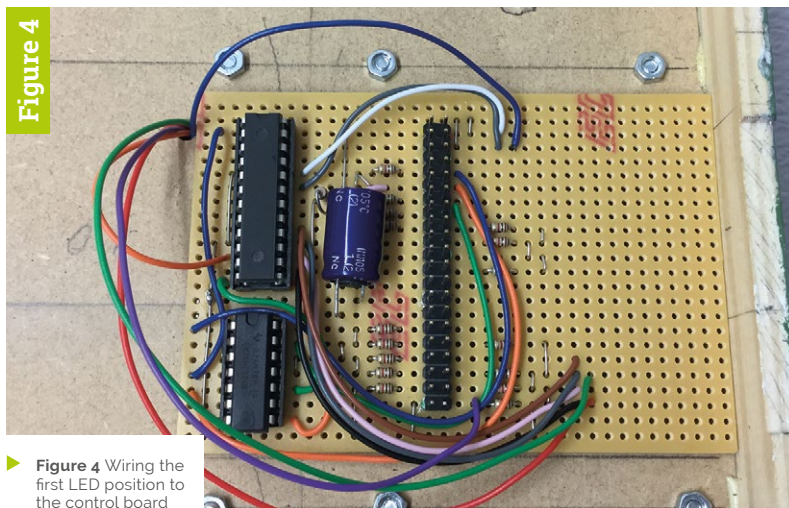

▶ Figure 4 Wiring the first LED position to the control board

Control Board

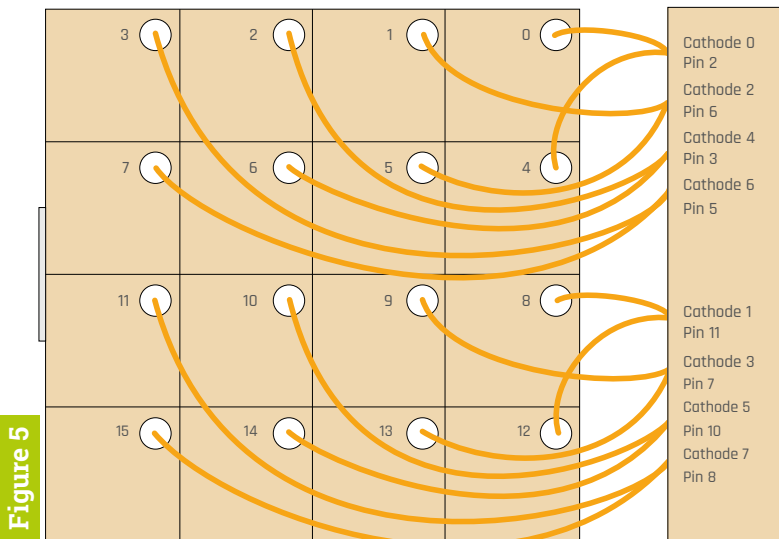

Figure 5

▲ Figure 5 The orange cathode wires

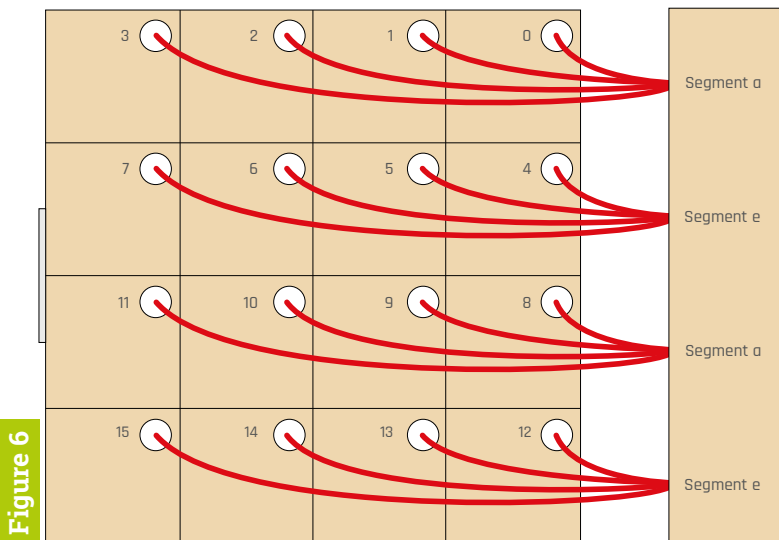

Figure 6

▲ Figure 6 The red segment a & e wires

### 03 The matrix circuit

The LED boards are wired up to the controller to form the matrix, this is shown in **Figure 3**. Each numbered module is an LED board (whose schematic was shown in Figure 11 in the first part of this tutorial, issue 73), and the connections out of this diagram – Co to C7, SW0 to SW15, and Seg a to Seg g, – go to the controller board schematic (Figure 6 in part two of this tutorial, issue 74). These three schematics form what is known as a hierarchical schematic, where a complex section of circuit is drawn as a block and that block has a schematic showing its circuitry. In this case there are three levels of hierarchy.

### 04 Starting the wiring

Place the controller board on the back of the tray next to the slot in the side at matrix position 11, and draw a line round it for reference. Then take the LED tray for position 10 and feed the wires through the hole in the board and clip the battery tray to the base on the front. Next, connect the five wires up to the controller board, as shown in **Figure 4**. We then added all the other LED modules and pulled the wires through the holes, without wiring them up so we weren't forever turning the box over.

### 05 Complete the wiring

Stand the lid of the box on four blocks so the LEDs are not being crushed by the bench. Then concentrate on one colour wire at a time; i.e. wire up all the red wires from each LED to the control board, then the blue and so on. They all go to one of two places on the control board, with the exception of the violet switch wires: these go to different GPIO pins on the ribbon cable header. **Figures 5 to 9** show the wiring for each individual LED wire. Note that the control board has been separated for clarity.

## Top Tip



### Attaching wires to the LED boards

We used a reel of solder as a weight to anchor the wires to the bench, and some snipe-nose pliers to prevent the LED boards from flipping over while soldering the wires.



## Top Tip

Remember the special one

Matrix position 11 has the wire entry hole in a different place to the others, so that it does not come up underneath the control board.

### 06 Attaching the matrix to the Pi

To attach the Matrix to the Pi, we use two 40-way IDCs (insulation displacement connectors) and an approximately 600 mm length of 40-way ribbon cable. Line up the cable in the connector, with the arrow on the left-hand side pointing towards the red conductor. Then tighten the vice up slowly until the connectors pierce the cable completely (**Figure 10**, overleaf). Crimp up the other end of the cable, and make sure the connectors are placed as seen in **Figure 11** (overleaf). Finally, loop the cable over itself at the Pi end and fit a strain-relief clip if you have one.

### 07 Testing the circuit

Let's test the hardware. Type in and run the code in **Matrix\_test.py**. This will, at first, turn on the red LED of each switch. Pressing that switch will turn the LED green; press again for a blue. The final press will turn all the LEDs on that switch off. A printout is given when any switch is changed. If this does not happen then check the control board for short circuits and the wiring for correct routing. Note, at this stage sometimes the LEDs will randomly toggle while the Pi is busy – we will fix that later in the final code.

### 08 Fixing the LED boards

The LED boards need to be fastened down, to prevent the wires pushing them up and stopping the switches from operating correctly. We found the best way was to use a small amount of hot-melt glue. Remove the labels in the battery tray, align the LED boards with the reflector, then apply a small round dab of hot-melt glue to the bottom of the LED board, and quickly push it into place, using the reflector to ensure it is lined up with the reflector pegs on the battery case.

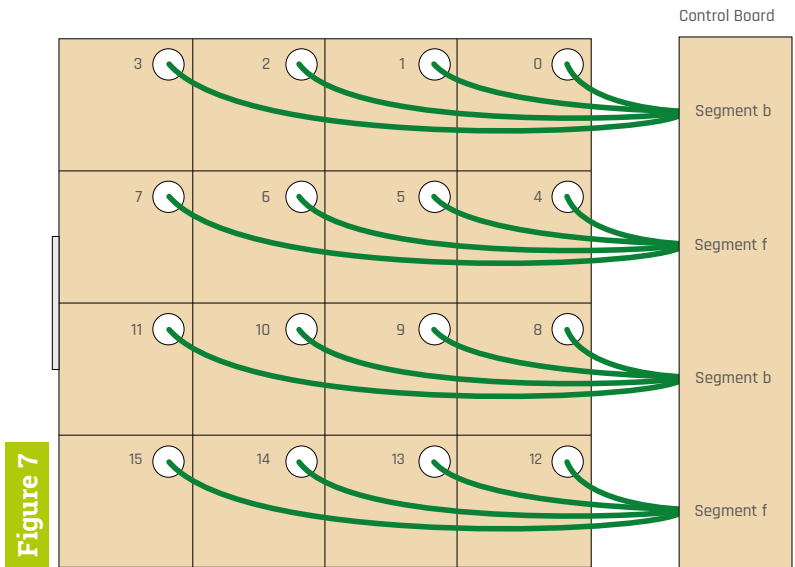

▲ Figure 7 The green segment b & f wires

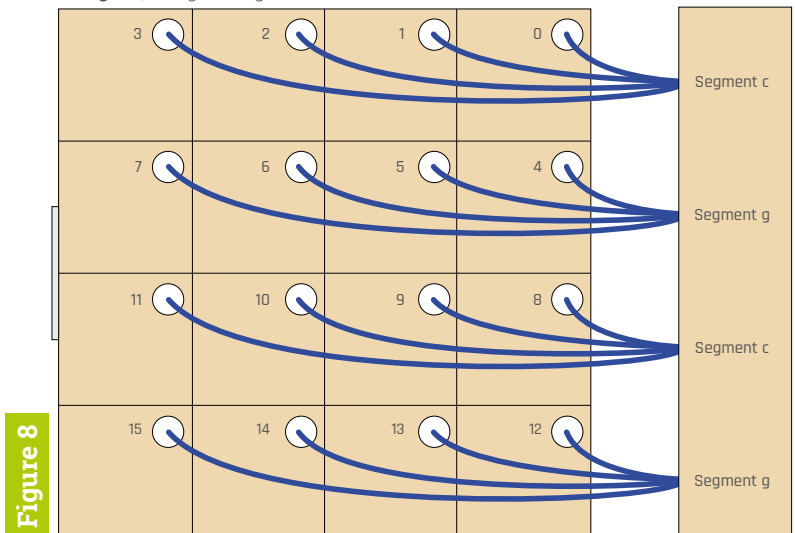

▲ Figure 8 The blue segment c & g wires

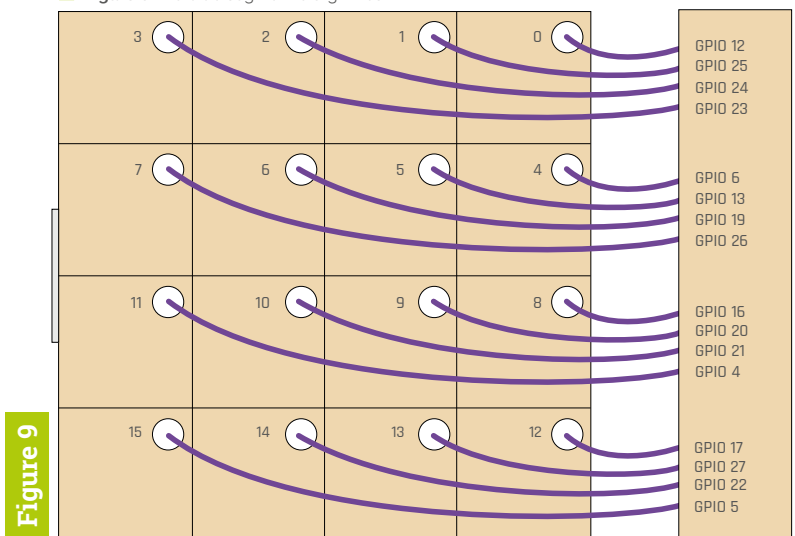

▲ Figure 9 The violet switch wires

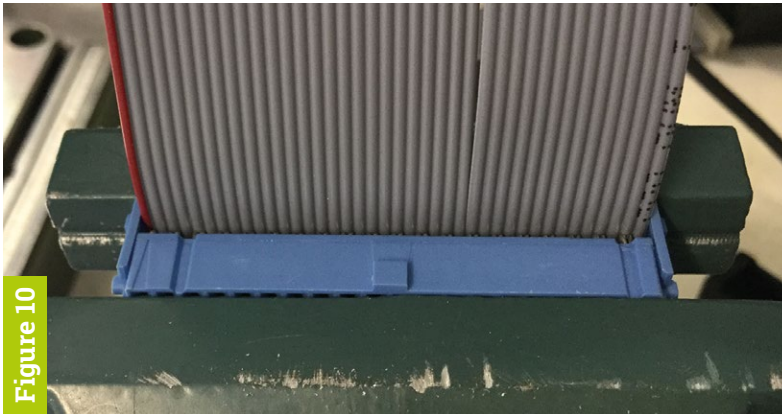

Figure 10

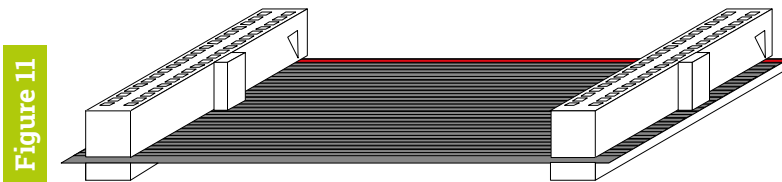

Figure 11

✦ Figure 10 Crimping the ribbon cable to the connector

▲ Figure 11 The final cable

## 09 Final assembly

We found that when the cover, lens, and reflector were placed over the LED, there was not enough travel to make the switch turn on and off reliably due to the wires on the underside of the LED board. So we increased the travel on the switch by removing the small raised part on the back of the reflector with a flat-ended router bit. You can use either a pillar drill with the router in the chuck, a hand-held drill or Dremel, or you can use a scalpel. **Figure 12** shows the three stages of this process: before, during, and after.

With the hardware tested and working, next month we will see how to adapt our test code, and make it into a fully-fledged Python library. Then we will start to use that library to put our Matrix to work. [M](#)

▶ Figure 12 Removing the switch pips



Figure 12

## Matrix\_test.py

```

001. import time
002. import RPi.GPIO as io
003.
004. dataPin = 14 ; clockPin = 15 ;
    loadPin = 18 ; buttons = 0 ;
    oldButtons = 0
005. buttonPins = [12,25,24,23,6,13,19,26,
    16,20,21,4,17,27,22,5] # rows
006. ledsState = [ 0,0,0,0,0,
    0,0,0,0,0,0,0,0,0,0]
    #0=off,1=red,2=green,3=blue
007. ledCol = [0,64,32,16,0,4,2,1]
    # LED colour number
008. register = [0,0,0,0,0,0,0,0,0]
    # copy of the Max chip's registers
009. address = [1,3,5,7, 1,3,5,7,
    2,4,6,8, 2,4,6,8] # switch number to
    register address
010. colOff = [0,0,0,0, 4,4,4,4,
    0,0,0,0, 4,4,4,4] # colour offset per
    switch
011.
012. def main():
013.     global register
014.     print("Matrix test")
015.     init_io()
016.     init_max7219()
017.     time.sleep(0.04)
018.     clrLED()
019.     readButtons()
020.     for switch in range(0,16):
021.         setLed(switch,ledsState[switch])
022.     while True:
023.         for switch in range (0,16):
024.             readButtons()
025.             if buttonsChanged :
026.                 print("Bit pattern",
    fullBin(buttons),
    " Number =",buttons,)
027.                 for switch in range(0,16):
028.                     if buttons & (1 <<
    switch) != oldButtons &
    (1 << switch) :
029.                         print(
    "changing switch number",switch)
030.                         setLed(switch,
    ledsState[switch])

```



**DOWNLOAD  
THE FULL CODE:**



[magpi.cc/1NqJjmV](https://magpi.cc/1NqJjmV)

```

031.         time.sleep(0.2)
032.
033. def setLed(switch,col): # increment LED state &
    display
034.     global register
035.     reg = address[switch]
036.     ledsState[switch] += 1
037.     if ledsState[switch] >3 :
038.         ledsState[switch] = 0
039.     if colOff[switch] == 0 :
040.         register[reg] &= 0x0F # clear bottom bits
041.     else:
042.         register[reg] &= 0xF0 # clear top bits
043.         register[reg] |=
    ledCol[colOff[switch]+ledsState[switch]]
044.         sendMax(address[switch],register[reg])
045.
046. def fullBin(num): # to show all leading zeros
047.     binary = ""
048.     for i in range(15,-1,-1):
049.         if num & (1 << i):
050.             binary = binary +"1"
051.         else:
052.             binary = binary +"0"
053.     return binary
054.
055. def init_io():
056.     io.setmode(io.BCM)
057.     io.setwarnings(False)
058.     for i in range (0, len(buttonPins)):
059.         io.setup(buttonPins[i], io.IN,
    pull_up_down=io.PUD_UP)
060.     io.setup(dataPin, io.OUT) # data out
061.     io.output(dataPin, 0)
062.     io.setup(clockPin, io.OUT) # clock
063.     io.output(clockPin, 0)
064.     io.setup(loadPin, io.OUT) # not load
065.     io.output(loadPin, 1)
066.
067. def readButtons():
068.     global buttons, buttonsChanged, oldButtons
069.     buttonsChanged = False
070.     oldButtons = buttons
071.     newBut = 0
072.     for i in range (0, len(buttonPins)):
073.         edge = io.wait_for_edge(buttonPins[i],
    io.FALLING,1,2)
074.         if edge == None:
075.             newBut &= 0xFFFF ^ (1<< i) # clear bit in
    variable
076.         else:
077.             newBut |= 1<< i # set bit in variable
078.         if newBut != buttons : # we have a changed from
    last time
079.             buttons = newBut
080.             buttonsChanged = True
081.
082. def clrLED():
083.     for add in range(1,9): # all display registers
084.         sendMax(add,0)
085.
086. def init_max7219():
087.     sendMax(0x9,0) # no decode
088.     sendMax(0xB,7) # scan all digits
089.     sendMax(0xA,0x15) # maximum intensity
090.     sendMax(0xC,1) # take out of shutdown mode
091.
092. def sendMax(add,data): # send a byte to mux chip
093.     package = add << 8 | data # join into one bit
    pattern
094.     io.output(loadPin, 0) # lower load
095.     for i in range(15,-1,-1): # from 15 to 0
096.         io.output(dataPin, 1 & (package >> i)) # send
    MSB first
097.         io.output(clockPin, 1) # toggle clock
098.         io.output(clockPin, 0)
099.         io.output(loadPin, 1) # latch value
100.
101. # Main program logic:
102. if __name__ == '__main__':
103.     main()

```

## Start with issue 73

This is the latest instalment in a series of Mike's Pi Bakery tutorials. You can download digital editions of previous tutorials for free. Start with *The MagPi* #73.

[magpi.cc/73](https://magpi.cc/73)



# Pygame Zero Invaders II



**Mark Vanstone**

Educational software author from the nineties, author of the ArcVenture series, disappeared into the corporate software wasteland. Rescued by the Raspberry Pi!

[magpi.cc/YiZnXl](http://magpi.cc/YiZnXl)  
@mindexplorers

Space Invaders must be the first computer game that springs to mind for a lot of people. Here in part two we will take our basic game from part one and add all the extras

In part one, last issue, we set up the basics for our Space Invaders game with our player ship controlled by the keyboard, defence bases, the aliens moving backwards and forwards across the screen, and lasers flying everywhere. In this part we will add lives and levels to the game, introduce a bonus alien, code a leader board for high scores, and add some groovy sound effects. We may even get round to adding an introduction screen if we get time. We are going to start from where we left off in part one. If you don't have the part one code and files, you can download them from GitHub at [magpi.cc/JxQrdd](http://magpi.cc/JxQrdd).

## 01 You only live thrice

It was a tradition with Space Invaders to be given three lives at the start of the game. We can easily set up a place to keep track of our player lives by writing `player.lives = 3` in our `init()` function. While we are in the `init()` function, let's add a player name variable with `player.name = ""` so that we can show names on our leader board, but we'll come to that in a bit. To display the number of lives our player has, we can add `drawLives()` to our `draw()` function and then define our `drawLives()` function containing a loop which 'blits' `life.png` once for each life in the top left of the screen.

## You'll Need

- ▶ An image manipulation program such as GIMP, or images from [magpi.cc/mYSswY](http://magpi.cc/mYSswY)
- ▶ The latest version of Pygame Zero (1.2)
- ▶ The Audacity sound editor or similar or sounds available from [magpi.cc/mYSswY](http://magpi.cc/mYSswY)
- ▶ Speakers or headphones





## 02 Life after death

Now we have a counter for how many lives the player has, we will need to write some code to deal with what happens when a life is lost. In part one we ended the game when the `player.status` reached 30. In our `update()` function we already have a condition to check the `player.status` and if there are any aliens still alive. Where we have written `if player.status == 30:` we can write `player.lives -= 1`. We can also check to see if the player has run out of lives when we check to see if the `RETURN` (aka `ENTER`) key is pressed.

## 03 Keep calm and carry on

Once we have reduced `player.lives` by one and the player has pressed the `RETURN` key, all we need to do to set things back in motion is to set `player.status = 0`. We may want to reset the laser list too, because if the player was hit by a flurry of lasers we may find that several lives are lost without giving the player a chance to get out of the way of subsequent lasers. We can do this by writing `lasers = []`. If the player has run out of lives at this point, we will send them off to the leader-board page. See [figure1.py](#) to examine the code for dealing with lives.

## 04 On the level

The idea of having levels is to start the game in an easy mode; then, when the player has shot all the aliens, we make a new level which is a bit harder than the last. In this case we are going to tweak a few variables to make each level more difficult. To start, we can set up a global variable `level = 1` in our `init()` function. Now we can use our `level` variable to alter things as we increase the value. Let's start by speeding up how quickly the aliens move down the screen as the level goes up. When we calculate the `movey` value in `updateAliens()`, we can write `movey = 40 + (5*level)` on the condition that `moveSequence` is 10 or 30.

## 05 On the up

To go from one level to the next, the player will need to shoot all the aliens. We can tell if there are any aliens left if `len(aliens) = 0`. So, with that in mind, we can put a condition in our `draw()` function with `if len(aliens) == 0:` and

## figure1.py

```
001. def draw()
002.     # additional drawing code
003.     drawLives()
004.     if player.status >= 30:
005.         if player.lives > 0:
006.             drawCentreText(
007.                 "YOU WERE HIT!\nPress Enter to re-spawn")
008.         else:
009.             drawCentreText(
010.                 "GAME OVER!\nPress Enter to continue")
011.
012. def init():
013.     # additional player variables
014.     player.lives = 3
015.     player.name = ""
016.
017. def drawLives():
018.     for l in range(player.lives):
019.         screen.blit("life", (10+(l*32),10))
020.
021. def update():
022.     # additional code for life handling
023.     global player, lasers
024.     if player.status < 30 and len(aliens) > 0:
025.         if player.status > 0:
026.             player.status += 1
027.             if player.status == 30:
028.                 player.lives -= 1
029.         else:
030.             if keyboard.RETURN:
031.                 if player.lives > 0:
032.                     player.status = 0
033.                     lasers = []
034.                 else:
035.                     # go to the leader-board
036.                     pass;
037.
038. def drawCentreText(t):
039.     screen.draw.text(t, center=(400, 300), owidth=0.5,
040.                      ocolor=(255,255,255), color=(255,64,0), fontsize=60)
```

then draw text on the screen to say that the level has been cleared. We can put the same condition in the section of the `update()` function where we are waiting for `RETURN` to be pressed. When `RETURN` is pressed and the length of the aliens list is 0, we can add 1 to `level` and call `initAliens()` and `initBases()` to set things ready to start the new level.

▲ Code to deal with player lives. Notice the `drawCentreText()` function to short-cut printing text to the centre of the screen

## figure2.py

```

001. def updateBoss():
002.     global boss, level, player, lasers
003.     if boss.active:
004.         boss.y += (0.3*level)
005.         if boss.direction == 0: boss.x -= (1* level)
006.         else: boss.x += (1* level)
007.         if boss.x < 100: boss.direction = 1
008.         if boss.x > 700: boss.direction = 0
009.         if boss.y > 500:
010.             sounds.explosion.play()
011.             player.status = 1
012.             boss.active = False
013.             if randint(0, 30) == 0:
014.                 lasers.append(Actor("laser1",
(boss.x,boss.y)))
015.                 lasers[len(lasers)-1].status = 0
016.                 lasers[len(lasers)-1].type = 0
017.         else:
018.             if randint(0, 800) == 0:
019.                 boss.active = True
020.                 boss.x = 800
021.                 boss.y = 100
022.                 boss.direction = 0

```

▲ Code to update the boss or bonus alien. This code runs when the boss is active or uses random numbers to see if it's time to make it active

### 06 Front and centre

You may have noticed in [figure1.py](#) that we made a couple of calls to a function called `drawCentreText()` which we have not yet discussed. All that this function does is to shorten the process of writing text to the centre of the screen. We assume that the text will be positioned at coordinates (400, 300) and will have a set of standard style settings and colours, and the function definition just contains one line: `screen.draw.text(t, center=(400, 300), owidth=0.5, ocolor=(255,255,255), color=(255,64,0), fontsize=60)` – where `t` is passed into the function as a parameter.

### 07 Flying like a boss

To liven up our game a little bit, we are going to add in a bonus or boss alien. This could be triggered in various ways, but in this case we will start the boss activity with a random number. First we will need to create the boss actor. Because there will only ever be one boss alien on screen at any time, we can just use one actor created near the start of our code. In this case we don't need to

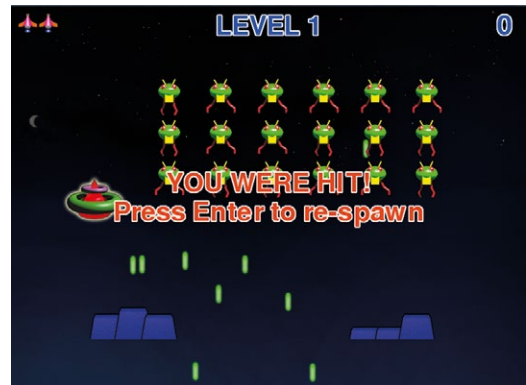

▲ Lasers can be very bad for your health. Best to avoid them

give it coordinates as we will start the game with the boss actor not being drawn. We write `boss = Actor("boss")`.

### 08 Keeping the boss in the loop

We want to start the game with the boss not being displayed, so we can add to our `init()` function `boss.active = False` and then in our `draw()` function `if boss.active: boss.draw()`, which will mean the boss will not be drawn until we make it active. In our `update()` function, along with our other functions to update elements, we can call `updateBoss()`. This function will update the coordinates of the boss actor if it is active or, if it is not, check to see if we need to start a new boss flying. See [figure2.py](#) for the `updateBoss()` function.

### 09 Did you hear that?

You may have noticed that in [figure2.py](#) we have an element of Pygame Zero that we have not discussed yet, and that is sound. If we write `sounds.explosion.play()`, then the sound file located at `sounds/explosion.wav` will be played. There are many free sound effects for games on the internet. If you use a downloaded WAV file, make sure that it is fairly small. You can edit WAV sound files with programs like Audacity. We can add sound code to other events in the program in the same way, like when a laser is fired.

### 10 More about the boss

Staying with [figure2.py](#), note how we can use random numbers to decide when the boss becomes active and also when the boss fires a laser. You can change the parameters of the `randint()` function to alter the occurrence of these



events. You can also see that we have a simple path calculating system for the boss to make it move diagonally down the screen. We use the `level` variable to alter aspects of the movement. We treat the boss lasers in the same way as the normal alien lasers, but we need to have a check to see if the boss is hit by a player laser. We do this by adding a check to our `checkPlayerLaserHit()` function.

## 11 Three strikes and you're out

In the previous episode, the game ended if you were hit by a laser. In this version we have three chances before the game ends, and when it does, we want to display a high score table or leader board to be updated from one player to the next. There are a few considerations to think about here. We need a separate screen for our leader board; we need to get players to enter their name to put against each score and we will have to save the score information. In other programs in this series we have used the variable `gameStatus` to control different screens, so let's bring that back for this program.

## 12 Screen switching with `gameStatus`

We will need three states for the `gameStatus` variable. If it is set to 0 then we should display an intro screen where we can get the player to type in their name. If it is set to 1 then we want to run code for playing the game. And if it is set to 2 then we display the leader-board page. Let's first deal with the intro screen. Having set our variable to 0 at the top of the code, we need to add a condition to our `draw()` function: `if gameStatus == 0:`. Then, under that, use `drawCentreText()` to show some intro text and display the `player.name` string. To start with, `player.name` will be blank.

## 13 A name is just a name

Now to respond to the player typing their name into the intro screen. We will write a very simple input routine and put it in the built-in Pygame Zero function `on_key_down()`. `figure3.py` shows how we do this. With this code, if the player presses a key, the name of the key is added to the `player.name` string unless the key is the `BACKSPACE` key, in which case we remove the last character. Notice the rather cunning way of doing

## figure3.py

```
001. def on_key_down(key):
002.     global player
003.     if gameStatus == 0 and key.name != "RETURN":
004.         if len(key.name) == 1:
005.             player.name += key.name
006.         else:
007.             if key.name == "BACKSPACE":
008.                 player.name = player.name[:-1]
```

that with `player.name = player.name[:-1]`. We also ignore the `RETURN` key, as we can deal with that in our `update()` function.

▲ Code for capturing keyboard input for the player to input their name on the introduction screen

## 14 Game on

When the player has entered their name on the intro screen, all we need to do is detect a press of the `RETURN` key in our `update()` function and we can switch to the game part. We can easily do this by just writing `if gameStatus == 0:` and then under that, `if keyboard.RETURN and player.name != "": gameStatus = 1`. We will also now need to put our main game update code under a condition, `if gameStatus == 1:`. We will also need to have the same condition in the `draw()` function. Once this is done, we have a system for switching from intro screen to game screen.

## 15 Leader of the pack

So now we come to our leader-board screen. It will be triggered when the player loses the third life. When that happens, we set `gameStatus` to 2 and put a condition in our `draw()` and `update()` functions to react to that. When we switch to our leader board, we need to display the high score list – so, we can write in our `draw()` function: `if gameStatus == 2: drawHighScore()`. Going back to `figure1.py`, you'll see that we left a section at the end commented out, ready for the leader board. We can now fill this in with some code.

## 16 If only I learned to read and write

We are going to save all our scores in a file so that we can get them back each time the

## Start with issue 71

This is the latest instalment in a series of Pygame Zero tutorials. You can download digital editions of previous tutorials for free. Start with *The MagPi* #71.

[magpi.cc/71](http://magpi.cc/71)



## figure4.py

```

001. def readHighScore():
002.     global highScore, score, player
003.     highScore = []
004.     try:
005.         hsFile = open("highscores.txt", "r")
006.         for line in hsFile:
007.             highScore.append(line.rstrip())
008.     except:
009.         pass
010.     highScore.append(str(score)+ " " + player.name)
011.     highScore.sort(key=natural_key, reverse=True)
012.
013. def natural_key(string_):
014.     return [int(s) if s.isdigit() else s for s in
re.split(r'(\d+)', string_)]
015.
016. def writeHighScore():
017.     global highScore
018.     hsFile = open("highscores.txt", "w")
019.     for line in highScore:
020.         hsFile.write(line + "\n")
021.
022. def drawHighScore():
023.     global highScore
024.     y = 0
025.     screen.draw.text("TOP SCORES", midtop=(400, 30),
owidth=0.5, ocolor=(255,255,255), color=(0,64,255) ,
fontsize=60)
026.     for line in highScore:
027.         if y < 400:
028.             screen.draw.text(line, midtop=(400, 100+y),
owidth=0.5, ocolor=(0,0,255), color=(255,255,0) ,
fontsize=50)
029.             y += 50
030.             screen.draw.text("Press Escape to play again" ,
center=(400, 550), owidth=0.5, ocolor=(255,255,255),
color=(255,64,0) , fontsize=60)

```

▲ Code for reading, writing, sorting, and drawing the high score leader board

game is played. We can use a simple text file for this. When a new score is available, we will have to read the old score list in, add our new score to the list, sort the scores into the correct order, and then save the scores back out to create an updated file. So, the code we need to write in our `update()` function will be to call a `readHighScore()` function, set our `gameStatus` to 2, and call a `writeHighScore()` function.



▲ All the aliens have been destroyed. It's time to move up a level

### 17 Functions need to function

We have named three functions that need writing in the last couple of steps: `drawHighScore()`, `readHighScore()`, and `writeHighScore()`. Have a look at `figure4.py` to see the code that we need in these functions. The file reading and writing are standard Python functions. When reading, we create a list of entries and add each line to a list. We then sort the list into highest-score-first order. When we write the file, we just write each list item to the file. To draw the leader board, we just run through the high-score list that we have sorted and draw the lines of text to the screen.

### 18 Sort it out

It's worth mentioning the way we are sorting the high scores. In `figure4.py` we are adding a key sorting method to the list sorting function. We do this because the list is a string but we want to sort by the high score, which is numerical, so we break up the string and convert it to an integer and sort based on that value rather than the string. If we didn't do this and sorted as a string then all the scores starting with 9 would come first, then all the 8s, then all the 7s and so on, with 9000 being shown before 80000, which would be wrong.

### 19 Well, that's all folks

That's about all we need for our Pygame Zero Invaders game other than all the additions that you could make to it. For example, you could have different graphics for each row of aliens. We're sure you can improve on the sounds that we have supplied, and there are many ways that the `level` variable can be worked into the code to make the different levels more difficult or more varied. [M](#)



## invaderspart2.py

**DOWNLOAD  
THE FULL CODE:**

[magpi.cc/gRWABf](https://magpi.cc/gRWABf)

```

001. import pgzrun, math, re, time
002. from random import randint
003. player = Actor("player", (400, 550))
004. boss = Actor("boss")
005. gameStatus = 0
006. highScore = []
007.
008. def draw(): # Pygame Zero draw function
009.     screen.blit('background', (0, 0))
010.     if gameStatus == 0: # display the title page
011.         drawCentreText("PYGAME ZERO INVADERS\n\n
nType your name then\npress Enter to start\n(arrow
keys move, space to fire)")
012.         screen.draw.text(player.name ,
center=(400, 500), owidth=0.5, ocolor=(255,0,0),
color=(0,64,255) , fontsize=60)
013.         if gameStatus == 1: # playing the game
014.             player.image =
player.images[math.floor(player.status/6)]
015.             player.draw()
016.             if boss.active: boss.draw()
017.             drawLasers()
018.             drawAliens()
019.             drawBases()
020.             screen.draw.text(str(score) ,
topright=(780, 10), owidth=0.5,
ocolor=(255,255,255), color=(0,64,255) ,
fontsize=60)
021.             screen.draw.text("LEVEL " +
str(level) , midtop=(400, 10), owidth=0.5,
ocolor=(255,255,255), color=(0,64,255) ,
fontsize=60)
022.             drawLives()
023.             if player.status >= 30:
024.                 if player.lives > 0:
025.                     drawCentreText(
"YOU WERE HIT!\nPress Enter to re-spawn")
026.                 else:
027.                     drawCentreText(
"GAME OVER!\nPress Enter to continue")
028.                 if len(alien) == 0 :
029.                     drawCentreText("LEVEL CLEARED!\nPress
Enter to go to the next level")
030.                 if gameStatus == 2: # game over show the
leaderboard
031.                     drawHighScore()
032.
033. def drawCentreText(t):
034.     screen.draw.text(t , center=(400, 300),
owidth=0.5, ocolor=(255,255,255), color=(255,64,0)
, fontsize=60)
035.
036. def update(): # Pygame Zero update function
037.     global moveCounter, player, gameStatus,
lasers, level, boss
038.     if gameStatus == 0:
039.         if keyboard.RETURN and player.name != "":
gameStatus = 1
040.
041.     if gameStatus == 1:
042.         if player.status < 30 and len(alien) > 0:
checkKeys()
updateLasers()
updateBoss()
043.         if moveCounter == 0: updateAliens()
moveCounter += 1
044.         if moveCounter == moveDelay:
moveCounter = 0
045.         if player.status > 0:
player.status += 1
046.         if player.status == 30:
player.lives -= 1
047.     else:
048.         if keyboard.RETURN:
049.             if player.lives > 0:
player.status = 0
050.             lasers = []
051.             if len(alien) == 0:
level += 1
boss.active = False
052.             initAliens()
053.             initBases()
054.         else:
055.             readHighScore()
056.             gameStatus = 2
057.             writeHighScore()
058.
059.     if gameStatus == 2:
060.         if keyboard.ESCAPE:
061.             init()
062.             gameStatus = 0
063.
064. def on_key_down(key):
065.     global player
066.     if gameStatus == 0 and key.name != "RETURN":
067.         if len(key.name) == 1:
player.name += key.name
068.         else:
069.             if key.name == "BACKSPACE":
player.name = player.name[:-1]
070.
071. def readHighScore():
072.     global highScore, score, player
073.     highScore = []
074.     try:
075.         hsFile = open("highscores.txt", "r")
076.         for line in hsFile:
highScore.append(line.rstrip())
077.     except:
078.         pass
079.     highScore.append(str(score)+ " " +
player.name)

```

```

092.     highScore.sort(key=natural_key, reverse=True)
093.
094. def natural_key(string_):
095.     return [int(s) if s.isdigit() else s for s in
re.split(r'(\d+)', string_)]
096.
097. def writeHighScore():
098.     global highScore
099.     hsFile = open("highscores.txt", "w")
100.     for line in highScore:
101.         hsFile.write(line + "\n")
102.
103. def drawHighScore():
104.     global highScore
105.     y = 0
106.     screen.draw.text("TOP SCORES", midtop=
(400, 30), owidth=0.5, ocolor=(255,255,255),
107. color=(0,64,255), fontsize=60)
108.     for line in highScore:
109.         if y < 400:
110.             screen.draw.text(line, midtop=
(400, 100+y), owidth=0.5, ocolor=(0,0,255),
111. color=(255,255,0), fontsize=50)
112.             y += 50
113.             screen.draw.text(
"Press Escape to play again", center=
(400, 550), owidth=0.5, ocolor=(255,255,255),
114. color=(255,64,0), fontsize=60)
115.
116. def drawLives():
117.     for l in range(player.lives):
118.         screen.blit("life", (10+(l*32),10))
119.
120. def drawAliens():
121.     for a in range(len.aliens): aliens[a].draw()
122.
123. def drawBases():
124.     for b in range(len(bases)):
125.         bases[b].drawClipped()
126.
127. def drawLasers():
128.     for l in range(len(lasers)): lasers[l].draw()
129.
130. def checkKeys():
131.     global player, score
132.     if keyboard.left:
133.         if player.x > 40: player.x -= 5
134.     if keyboard.right:
135.         if player.x < 760: player.x += 5
136.     if keyboard.space:
137.         if player.laserActive == 1:
138.             sounds.gun.play()
139.             player.laserActive = 0
140.             clock.schedule(makeLaserActive, 1.0)
141.             lasers.append(Actor("laser2",
(player.x,player.y-32)))
142.             lasers[len(lasers)-1].status = 0
143.             lasers[len(lasers)-1].type = 1
144.             score -= 100
145.
146. def makeLaserActive():
147.     global player
148.     player.laserActive = 1
149.
150. def checkBases():
151.     for b in range(len(bases)):
152.         if l < len(bases):
153.             if bases[b].height < 5:
154.                 del bases[b]
155.
156. def updateLasers():
157.     global lasers, aliens
158.     for l in range(len(lasers)):
159.         if lasers[l].type == 0:
160.             lasers[l].y += 2
161.             checkLaserHit(1)
162.             if lasers[l].y > 600:
163.                 lasers[l].status = 1
164.             if lasers[l].type == 1:
165.                 lasers[l].y -= 5
166.                 checkPlayerLaserHit(1)
167.                 if lasers[l].y < 10:
168.                     lasers[l].status = 1
169.             lasers = listCleanup(lasers)
170.             aliens = listCleanup(aliens)
171.
172. def listCleanup(l):
173.     newList = []
174.     for i in range(len(l)):
175.         if l[i].status == 0:
176.             newList.append(l[i])
177.     return newList
178.
179. def checkLaserHit(1):
180.     global player
181.     if player.collidepoint((lasers[1].x,
lasers[1].y)):
182.         sounds.explosion.play()
183.         player.status = 1
184.         lasers[1].status = 1
185.         for b in range(len(bases)):
186.             if bases[b].collideLaser(lasers[1]):
187.                 bases[b].height -= 10
188.                 lasers[1].status = 1
189.
190. def checkPlayerLaserHit(1):
191.     global score, boss
192.     for b in range(len(bases)):
193.         if bases[b].collideLaser(lasers[1]):
194.             lasers[1].status = 1
195.         for a in range(len(aliens)):
196.             if aliens[a].collidepoint((lasers[1].x,
lasers[1].y)):
197.                 lasers[1].status = 1
198.                 aliens[a].status = 1
199.                 score += 1000
200.         if boss.active:
201.             if boss.collidepoint((lasers[1].x,

```



```

200. lasers[1].y)):
201.     lasers[1].status = 1
202.     boss.active = 0
203.     score += 5000
204.
205. def updateAliens():
206.     global moveSequence, lasers, moveDelay
207.     movex = movey = 0
208.     if moveSequence < 10 or moveSequence > 30:
209.         movex = -15
210.     if moveSequence == 10 or moveSequence == 30:
211.         movey = 40 + (5*level)
212.         moveDelay -= 1
213.     if moveSequence >10 and moveSequence < 30:
214.         movex = 15
215.     for a in range(len.aliens)):
216.         animate(alien[a], pos=(alien[a].x
+ movex, alien[a].y + movey), duration=0.5,
tween='linear')
217.         if randint(0, 1) == 0:
218.             alien[a].image = "alien1"
219.         else:
220.             alien[a].image = "alien1b"
221.             if randint(0, 5) == 0:
222.                 lasers.append(Actor("laser1",
(alien[a].x,alien[a].y)))
223.                 lasers[len(lasers)-1].status = 0
224.                 lasers[len(lasers)-1].type = 0
225.                 sounds.laser.play()
226.                 if alien[a].y > 500 and player.status ==
0:
227.                     sounds.explosion.play()
228.                     player.status = 1
229.                     player.lives = 1
230.                     moveSequence +=1
231.                     if moveSequence == 40: moveSequence = 0
232.
233. def updateBoss():
234.     global boss, level, player, lasers
235.     if boss.active:
236.         boss.y += (0.3*level)
237.         if boss.direction == 0:
238.             boss.x -= (1* level)
239.         else: boss.x += (1* level)
240.         if boss.x < 100: boss.direction = 1
241.         if boss.x > 700: boss.direction = 0
242.         if boss.y > 500:
243.             sounds.explosion.play()
244.             player.status = 1
245.             boss.active = False
246.             if randint(0, 30) == 0:
247.                 lasers.append(Actor("laser1",
(boss.x,boss.y)))
248.                 lasers[len(lasers)-1].status = 0
249.                 lasers[len(lasers)-1].type = 0
250.             else:
251.                 if randint(0, 800) == 0:
252.                     boss.active = True
253.                     boss.x = 800
254.                     boss.y = 100
255.                     boss.direction = 0
256.
257. def init():
258.     global lasers, score, player, moveSequence,
moveCounter, moveDelay, level, boss
259.     initAliens()
260.     initBases()
261.     moveCounter = moveSequence = player.status =
score = player.laserCountdown = 0
262.     lasers = []
263.     moveDelay = 30
264.     boss.active = False
265.     player.images =
["player","explosion1","explosion2","explosion3",
"explosion4","explosion5"]
266.     player.laserActive = 1
267.     player.lives = 3
268.     player.name = ""
269.     level = 1
270.
271. def initAliens():
272.     global aliens, moveCounter, moveSequence
273.     aliens = []
274.     moveCounter = moveSequence = 0
275.     for a in range(18):
276.         aliens.append(Actor("alien1", (210+
(a % 6)*80,100+(int(a/6)*64))))
277.         aliens[a].status = 0
278.
279. def drawClipped(self):
280.     screen.surface.blit(self._surf, (self.x-32,
self.y-self.height+30),(0,0,64,self.height))
281.
282. def collideLaser(self, other):
283.     return (
284.         self.x-20 < other.x+5 and
285.         self.y-self.height+30 < other.y and
286.         self.x+32 > other.x+5 and
287.         self.y-self.height+30 + self.height >
other.y
288.     )
289.
290. def initBases():
291.     global bases
292.     bases = []
293.     bc = 0
294.     for b in range(3):
295.         for p in range(3):
296.             bases.append(Actor("base1",
midbottom=(150+(b*200)+(p*40),520)))
297.             bases[bc].drawClipped =
drawClipped.__get__(bases[bc])
298.             bases[bc].collideLaser =
collideLaser.__get__(bases[bc])
299.             bases[bc].height = 60
300.             bc +=1
301.
302. init()

```

DOWNLOAD  
THE FULL CODE:

 [magpi.cc/FSLBTf](https://magpi.cc/FSLBTf)

Part 11

# Coding games on the Raspberry Pi in C/C++



**Brian Beuken**

Very old game programmer, now teaching very young game programmers a lot of bad habits at Breda University of Applied Science, in the Netherlands.

[magpi.cc/YxaUVQ](https://magpi.cc/YxaUVQ)

## You'll Need

- ▶ Code::Blocks  
`sudo apt-get codeblocks`
- ▶ GLM installed previously
- ▶ `stb_image.h` installed previously

But the future is 3D

Let's make some use of those crazy matrices. We've clearly demonstrated that we can avoid a lot of the crazy maths when working in 2D (see last issue's guide) but though it's slightly overkill, using matrices gives us access to a lot more features and abilities. So let's see how far we can push things.

## The third dimension

We have really been working in 3D already; our tiles and sprites are in fact 3D, but only in the same way a drawing on a flat piece of paper is 3D. Also, we've been using a viewpoint or camera view that has been effectively placed directly above the paper – keeping our Z coordinate at zero has let our 3D system happily display in 2D.

But what if we were to do a bit of origami on our paper and turn our flat paper into a nice cube? That's more or less the principles of 3D. Well, then we have to make some decisions, such as 'how is the cube placed in space?', 'on what axis or axes does it rotate around?'... If we look down on our cube and twiddle it about in our hand, we can see that different faces of the cube are visible at different times, and – also important to get a 3D sense of depth with our eye – we notice that the points or vertices of the cube are at different distances to our eye. Hopefully we can get a sense that our cube points can be tracked on x, y, and z points 'relative' to our eye, or camera.

**Figure 1** shows how a 3D scene can be 'projected' to a 2D flat space, due to being viewed relative to the camera.

Now consider what happens if you keep your head/eye perfectly still, and you move your cube up and to the left a bit. The cube is moving through space and, if our eye is still, it is moving off our screen, but we will maybe see a bit more of the faces on the front and right of the cube as it moves off.

So, as you can see, that's a bit complex. But wait, it gets worse: imagine this time that you hold the cube still, then move your head up slowly. In terms of your field of view, the cube is going to move down. Now imagine the cube rotating in your hand!

So there are two ways to move the cube in our field of view. But what if we do both at the same time? Now we've got two things moving: the cube, rotating and translating in space, and our eye, which is also capable of rotating and translating in space. We start to get the idea that what we see in our field of view very much depends on the relative position of all the objects in our space. Also, we need to ignore things that we can't see: if our cube is behind us, clearly we can't see it.

Now instead of our eye, our computer has to convert things in its idea of space, into images on our screen – or as we call it, our 'view plane'.

## Top Tip

Learn to love matrices

Matrices give us a way to transform any point in space, and in many different ways.



And that view of the world changes depending on where and how you view it (**Figure 2**, overleaf).

The maths involved is frankly staggering, but with matrices there is a very simple way to work out where on a screen each of our cube's eight corner points should be:

**Transformed Vertex** =  $V \times M$

Yup, just  $V \times M$ , where  $V$  is the vertex and  $M$  is a transformation matrix. It's true that there's still a massive amount of calculation going on under the hood, but we can be confident our maths library is handling that, and therefore we can view the concept in a simple, abstract way. It's a bit like offering someone a meal without going into a long description of its constituents and how you prepared and presented them.

We can simply multiply each vertex point by a matrix to get a new point, which is going

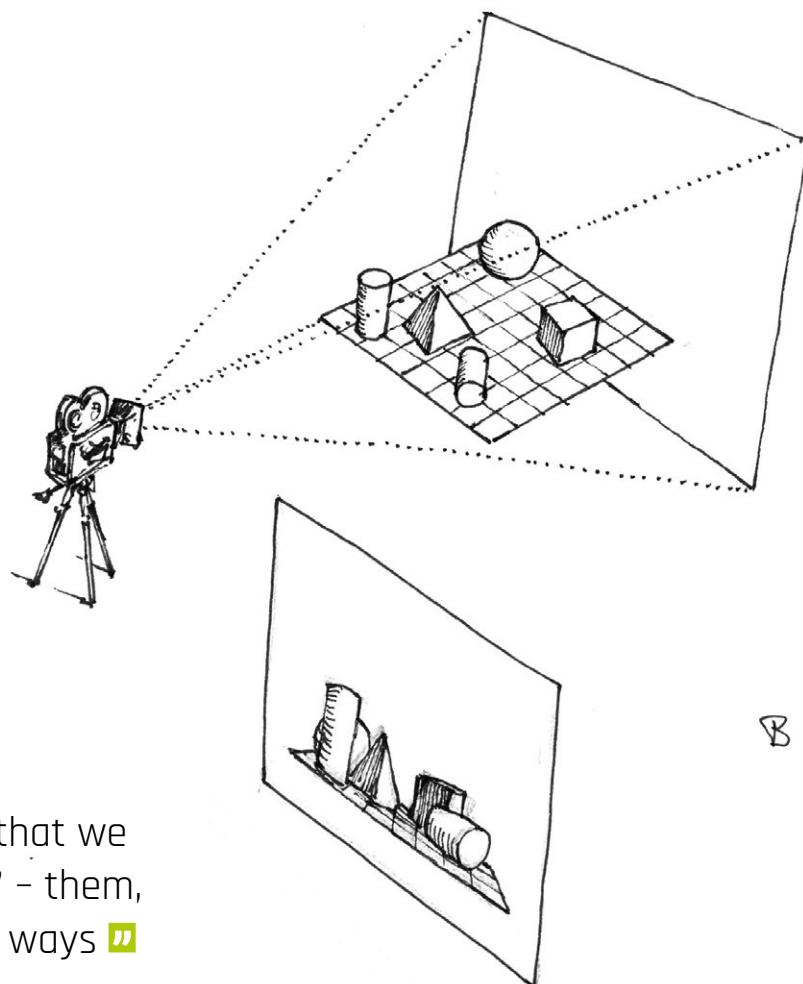

“ A great feature of matrices is that we can combine – or ‘concatenate’ – them, by multiplying them in specific ways ”

to represent a transformed point. The vertices might be different for each point, but the matrix is always the same. So computers, and GPUs especially, are designed to be effective at using and reusing this matrix and can calculate hundreds of thousands of new transformed vertices in rapid time. Stretching a texture on the UV points of those vertices, as we did with our tiles, gives us a sense of a solid 3D object.

A great feature of matrices is that we can combine – or ‘concatenate’ – them, by multiplying them in specific ways. So we can concatenate matrices and get the resulting matrix to produce the results of two, three, four, or more separate matrix multiplications.

Our matrices mainly focus on translation, scaling, and rotation, and both our camera and model can have this. So, by multiplying a camera matrix containing its rotation and location (scaling isn't really important to our camera yet) with our model's matrix, we get a single matrix that transforms any vertex in our 3D space.

There's a tiny complication related to the fact we want to maintain a sense of perspective in our depth so that we can tell things are far away,

because they will naturally appear to get smaller. This is also possible to represent in a matrix, called the ‘projection matrix’.

▲ **Figure 1** Projection lets us visualise a world as a screen

## Please, no more maths

Now that's not a full explanation of the maths – and it would take a lot more than four pages to really get into it – but as a simple explanation, we simply need to know that we have to create matrices for each model, for one camera, and also keep a fairly consistent projection matrix.

Once set up, we can feed our shaders with the model's relative values, and the specific matrix for its position, and boom... we get 3D!

Review the demo code, build and run it. At first, it all looks almost exactly the same. But press **Q** and **A**: these control a camera as it goes up and down in space, but keeping its gaze firmly on Bob.

Code-wise, our code has not really changed much: we are still playing with a 2D map in a 2D space. We're simply cheating a bit to visualise our tiles as cubes, and our sprites as a flat billboard which always faces the camera.

## Top Tip

Don't type in models

Although we have typed in cubes, 3D models can get very complex. It's much better to use a 3D modelling package for anything more than a cube.

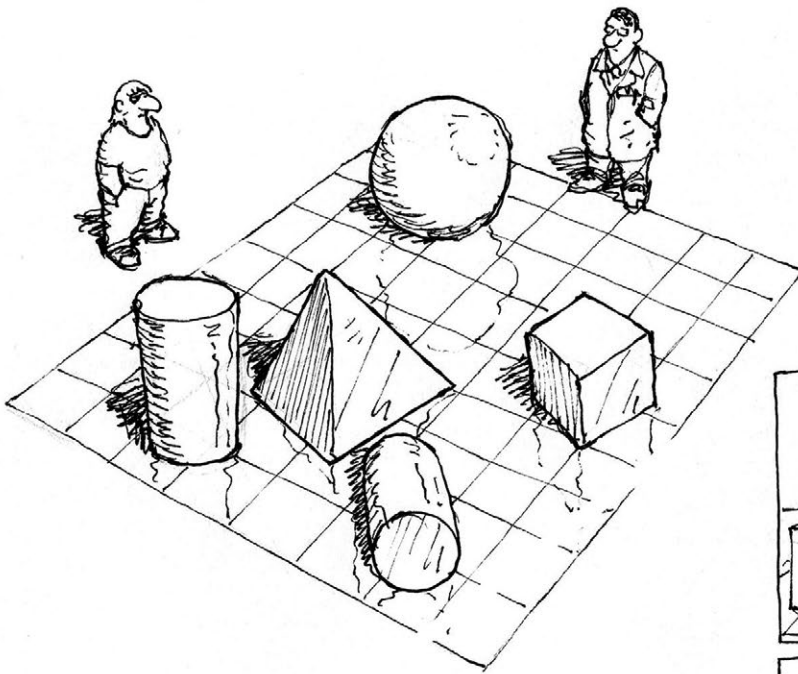

▲ **Figure 2** Our view of the world depends on from where we see it

It's a cool effect and it shows how 3D is not a massive leap – we just have to become a little more comfortable with working with cubes and spheres, rather than squares and circles.

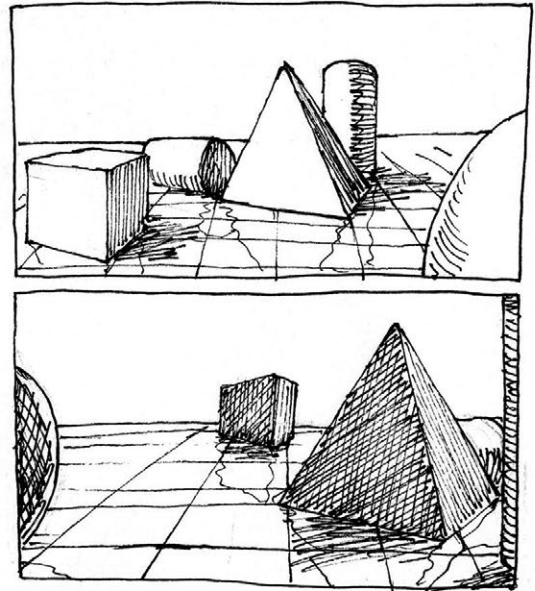

### Cleaning up the niggles

However we display our images, we still need our logic to be tighter and smoother. We want to take

“ Even the most powerful processors get bogged down by having to do too many unnecessary things ”

### Top Tip

Start to think relative

We still have a 2D map, but when we switch to full 3D, the concepts of left, right, up, and down will lose much of their meaning.

more care of how we hit walls and make our jumps a little less frustrating. It's not really a massive change, just an acceptance that we may have to do more than one test. Our Bob sprite is bigger than a tile, so if we only test his top or bottom, or even his middle corners, we may miss other points of contact.

Scanning a few points of contact makes sense, though, but only in the direction of travel. Take a look at the player's movement code, and you will see we scan more carefully.

But, notice that we don't take quite so much care with our baddies? This is simple an economy of effort. We are going to place those baddies at

specific locations, so it's logical to put them in places where we can comfortably predict the type of collision that will be most effective, in this case only testing their feet.

If, however, we wanted them to be much more general and placed anywhere, then we could adapt Bob's collision logic to work on them. There's a golden rule in coding games: never do more than you need to. Processors are very fast and can do a lot of processing in a single frame, but even the most powerful processors get bogged down by having to do too many unnecessary things. So at all times, keep your code as simple as possible to achieve only the result you need.

### Multiple maps

Having a more playable map in the new demo is great: it lets us see that our code works and it's shaping into a nice game. But one map on its own is going to get boring, so let's have multiple maps and let's also have different sizes.

Keeping track of the maps is a little tricky: we've written most of our code referring totally to Map2 – in effect, our code is hard-wired to only



use Map2. That's not very effective; we need to be able to let our code use any map, at least a map that conforms to our definition of a map.

By making the map a variable, it's a simple job to plug in a new map, so long as they are all the same size. In fact, we can keep a whole range of them. It does get a bit more complex if you don't know the size, but really if you have an unknown size of an array, we should really use the much more useful `STD::vector` structure, which is a dynamic array we can set to be any size we need.

### Next time

Our very simple little game is complete, and although you may not realise it, you've used a number of basic concepts to make this work

which are common in many game genres. In our next – and sadly final – article, we'll look back at these concepts and show you how to adapt them to work on almost any kind of game, and give tips on improving performance. [M](#)

## Learn more about C

Brian has a whole book on the subject of making games C and C++, called *The Fundamentals of C/C++ Game Programming: Using Target-based Development on SBCs*. Grab it here: [magpi.cc/nUkjEt](http://magpi.cc/nUkjEt)

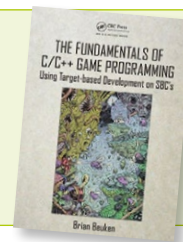

## Top Tip

Try to improve your maths

Still a valid tip from last time: maths is the most scary thing in coding, but a small understanding can go a long way.

# Connecting Raspberry Pi to FPGA through USB

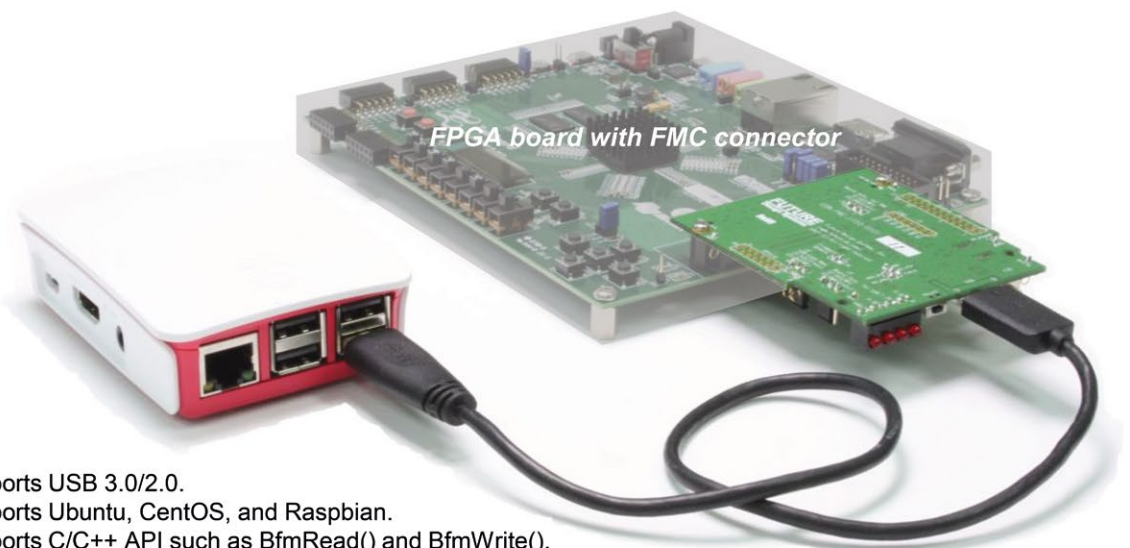

- CON-FMCTM supports USB 3.0/2.0.
- CON-FMCTM supports Ubuntu, CentOS, and Raspbian.
- CON-FMCTM supports C/C++ API such as `BfmRead()` and `BfmWrite()`.
- CON-FMCTM supports off-the-shelf FPGA board with FMC connector.
- CON-FMCTM supports FIFO interface and AMBA AXI/AHB/APB buses.
- CON-FMCTM supports CPU-to-FPGA offloading.

For additional information contact at [contact@future-ds.com](mailto:contact@future-ds.com) or visit [www.future-ds.com/CON-FMC](http://www.future-ds.com/CON-FMC)

**FUTURE**  
Design Systems

# Add vision with the **CAMERA** MODULE

The Pi Camera Module should be an essential piece of any digital maker's kit, as it can be used in a wide variety of projects. **Wesley Archer** puts us in the picture

**G**ive your Raspberry Pi the gift of sight with a Pi Camera Module ([magpi.cc/xSXqyL](http://magpi.cc/xSXqyL)). This handy attachment connects directly to the Raspberry Pi and is used in a wide range of vision-based projects.

Using a Raspberry Pi to monitor its surroundings is a fascinating subject, especially with the huge array of sensors, accessories, HATs, and PHATs available.

We've seen many exciting builds take advantage of these, but being able to see what is happening around your Raspberry Pi is very simple with the Pi Camera Module. These are some of the best projects for beginners. They're easy to set up and produce visible results.

Using the Camera Module is a great way to add an extra dimension to most projects. Let's get started...

## Regular or night vision?

The Pi Camera Module has two variants – the standard version and the NoIR version, which has the infrared filter removed to allow the camera to detect infrared light. It makes a great night-vision camera when used with an IR light source!

▼ Camera Module V2.1

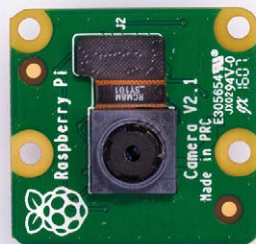

▼ Camera Module NoIR V2.1

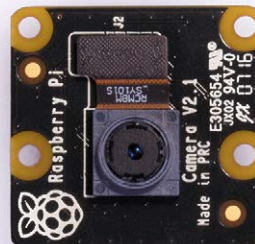





The Camera Module is small enough to fit inside bird-boxes or small project boxes

The small lens captures still images and video, which are saved to the Raspberry Pi

# SET UP YOUR CAMERA MODULE

Before you can start snapping away with the Camera Module, you'll need to connect it to the Raspberry Pi and test it out

## You'll Need

- ▶ Pi Camera Module  
[magpi.cc/kAtsHn](http://magpi.cc/kAtsHn)
- ▶ Pi Zero Camera Adapter (optional)  
[magpi.cc/uAUbdp](http://magpi.cc/uAUbdp)
- ▶ microSD card
- ▶ Raspbian

## Disable LED

The V1 Camera Module lights a red LED when activated (the V2 Camera doesn't have one). To disable this, add `disable_camera_led=1` to the `/boot/config.txt` file (and reboot).

- ▶ While small, the Camera Module takes high-resolution photos (up to 3280×2464 pixels) and captures HD video (up to 1080p) without breaking a sweat

Setting up a Camera Module couldn't be easier. You attach the Camera Module directly to the Camera Serial Interface (CSI) port on the Raspberry Pi board.

Connecting it to your Raspberry Pi is the same whether you own a Raspberry Pi 3+, a Pi Zero, or even an earlier Model B with 26 GPIO pins.

However, if you are going to connect a Camera Module to a Pi Zero (1.3, W, or WH), you'll need to use a Pi Zero Camera Adapter. This is often sold separately (£4, [magpi.cc/uAUbdp](http://magpi.cc/uAUbdp)), and sometimes included with the Official Pi Zero case ([magpi.cc/LECCmF](http://magpi.cc/LECCmF)).

If you received a Pi Zero W free with a subscription to *The MagPi* ([magpi.cc/subscribe](http://magpi.cc/subscribe)), you will have got a Zero Camera Adapter cable free with your Pi Zero W and Starter Kit.

Once you've got your Camera Module and Raspberry Pi, you use the cable to attach the two together. We'll show you how...

## 1 Connect the cable to a Raspberry Pi 2/3/3+

On a full-size Raspberry Pi, you will need to connect the camera cable to the Camera port nearest the Ethernet port. Gently lift the small plastic clasp on the Camera port and connect the camera cable with the blue part facing towards the Ethernet port, then gently push the clasp back down so it holds the cable in place.

## 2 Connect the cable to a Pi Zero W

The Pi Zero W has a smaller Camera port, but the official Pi Zero case usually includes the cable.

As with the full-size Raspberry Pi, gently pull the plastic clasp and then slot the camera cable in – you should see the white part facing upwards. You'll know if the cable is in correctly if the camera works, but it is best to check before booting your Raspberry Pi.

## 3 Connect the Camera Module

Similar to the way the camera cable connects to the Raspberry Pi, gently pull the small plastic clasp on the Camera Module and then slot the other end of the camera cable into the port – this time the blue part should be facing you, with the camera lens pointing the opposite direction. Gently close the clasp, locking the cable in place – the clasps can be fragile, so handle with care.

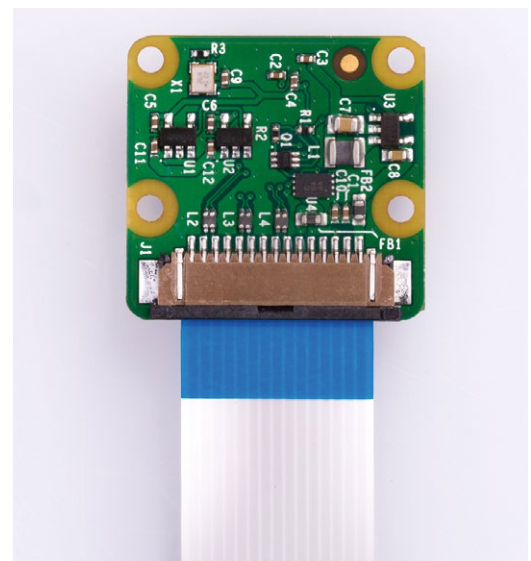



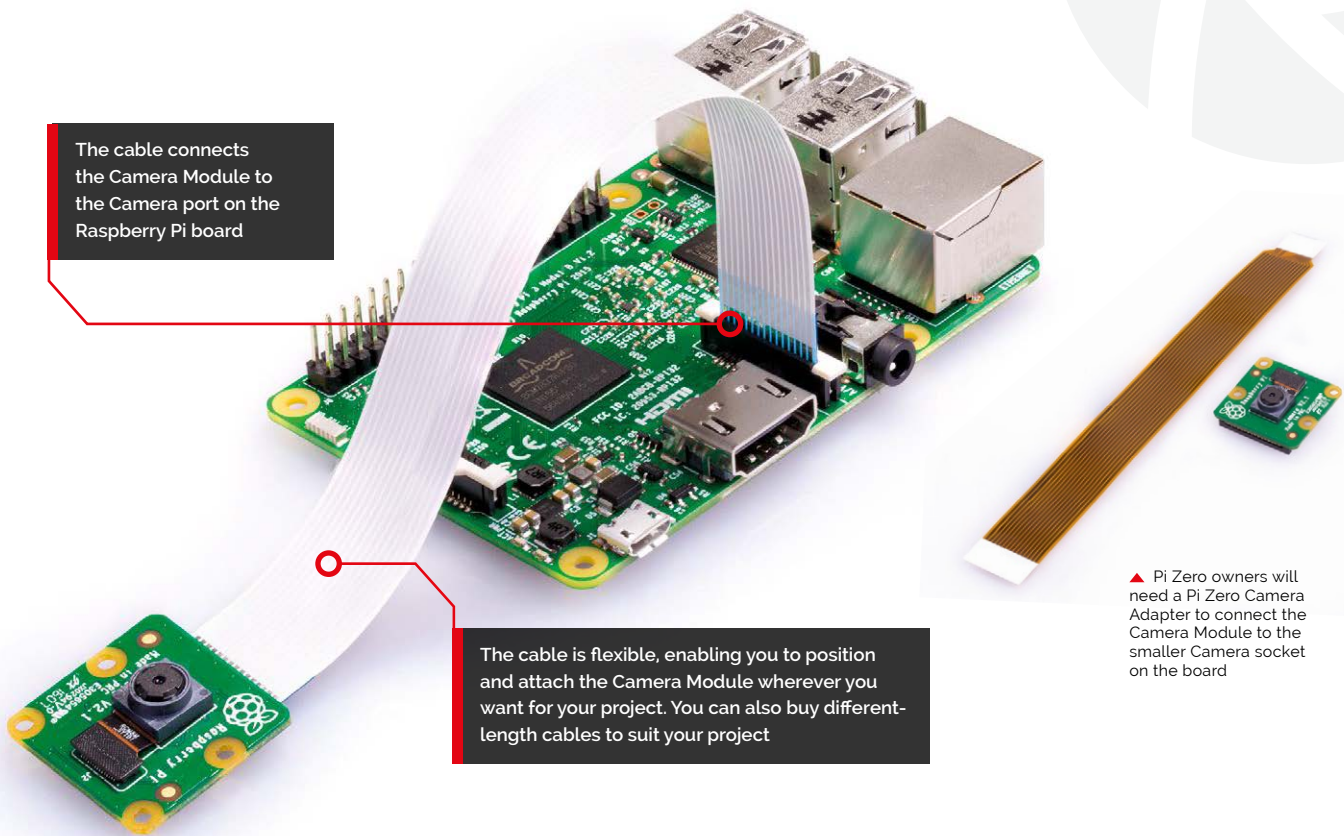

The cable connects the Camera Module to the Camera port on the Raspberry Pi board

The cable is flexible, enabling you to position and attach the Camera Module wherever you want for your project. You can also buy different-length cables to suit your project

▲ Pi Zero owners will need a Pi Zero Camera Adapter to connect the Camera Module to the smaller Camera socket on the board

## 4 Enable the Camera Module

By default, the Camera Module is not enabled in Raspbian, but it is very easy to enable. If you have your Raspberry Pi connected to a mouse, keyboard, and monitor, you can use the Raspberry Pi Desktop to enable the Camera function. Click on the raspberry icon (top left) and choose Preferences > Raspberry Pi Configuration. Click the Interfaces tab and set Camera to Enabled. Click OK; when prompted to reboot, click Yes.

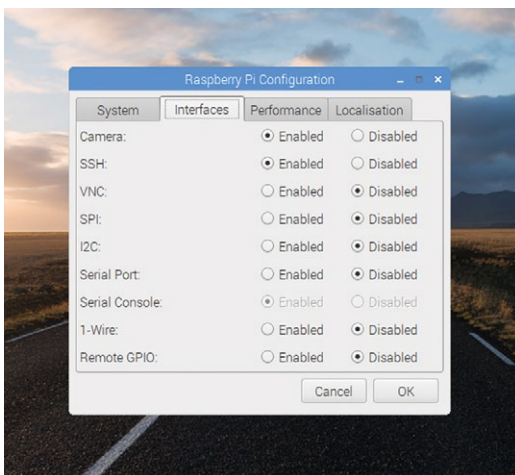

## 5 Enabling via SSH

If you are accessing your Raspberry Pi over SSH, you'll need to enable the camera via the command-line Raspberry Pi configuration tool instead. Enter the following in a Terminal window:

```
sudo raspi-config
```

Now select '5 - Interfacing Options > P1 - Camera' and choose <Yes> to enable the camera. Press **ENTER** on <Ok> and choose <Finish>. When asked to reboot, choose <Yes>. We're now set to snap away.

## 6 Test the Camera Module

Before diving into a project, it's worth testing your Camera Module works as expected first. Open a Terminal and enter this command:

```
raspistill -o /home/pi/hello.jpg
```

Smile for a few seconds - you can see yourself on the live camera preview - while the photo is taken and saved to the **/home/pi** directory. Why not open it in File Manager to see the results?

**Raspberry Pi Camera Case**

Using a full-sized Raspberry Pi? Why not buy a Raspberry Pi case designed to accommodate the Camera Module, such as the PiShell?

◀ You must activate the Camera interface in Raspberry Pi Configuration before using the camera

# CAMERA MODULE SETTINGS

Get the most out of your Camera Module by tweaking the various settings and creating different effects

## You'll Need

- > Pi Camera Module  
[magpi.cc/kAtsHn](http://magpi.cc/kAtsHn)
- > Pi Zero Camera Adapter (optional)  
[magpi.cc/uAUbdp](http://magpi.cc/uAUbdp)
- > microSD card
- > Raspbian

The Camera Module doesn't just snap photos – it also records video – but did you know that there are lots of different settings that can be applied to customise how the photo or video appears? In this guide, we're going to explore some of the settings and commands that can be used to tailor how you use the Camera Module in your project, and we'll explore some of the more quirky features too!

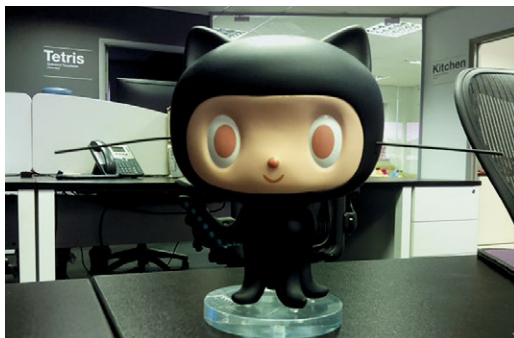

## 1 Adjusting resolution and brightness

The latest Camera Module has a maximum resolution for a photo of 3280×2464 pixels, but images this large can take up a lot of storage space over time and take longer to process by the Pi. Fortunately, raspistill, the program that captures photos on our Pi, allows us to specify the photo resolution very easily. For example, you can set the width (640 pixels) and height (480 pixels) using the `-w` and `-h` parameters accordingly. You can also specify the brightness with the `-br` parameter and a value between 0 and 100. The image above was taken with the NoIR Camera Module (hence the odd colours) using:

```
raspistill -w 640 -h 480 -br 40 -o /home/pi/hello.jpg
```

This demonstrates how you can take a smaller photo (640×480 pixels) with a brightness of 40, but feel free to experiment to see what works best.



## 2 Adding text

If you're old enough to remember actual printed photographs, then you may have noticed that some cameras added the date and time to record when the photo was taken. If you're too young to remember, don't worry as you've just learned something new! With raspistill you can add your own text to your photos too, using the `-a` or `--annotate` parameter. Take the following example:

```
raspistill -a 4 -a "Pi Camera %d-%m-%Y %X" -o /home/pi/text.jpg
```

The first `-a 4` part sets the bitmask notation in the metadata to record the time (more info on that here: [magpi.cc/zegeYup](http://magpi.cc/zegeYup)).

The second `-a` part includes our custom text (Pi Camera) and formats the date into dd-mm-yy (`%d-%m-%Y`) before adding the time (`%X`) and then saving the photo the Raspberry Pi directory as `text.jpg`.





**"You can add image effects to photos taken by the Camera Module, such as inverting the colours to a negative"**

### 3 Add image effects

Another quirky feature of raspistill is that you can add image effects to photos taken by the Camera Module, such as inverting the colours to a negative, making the photo look like a sketch, or even adding a cartoon effect. Now, before you all get carried away, some of the effects can be a little hit-and-miss, but they can add a cool look to your photos nonetheless! This is done by adding the `-ifx` parameter along with the desired effect (full breakdown available here: [magpi.cc/SuuECJ](http://magpi.cc/SuuECJ)).

The following example applies a negative effect to the photo, as well as adding our custom text, date, and time:

```
raspistill -ifx negative -a 4 -a "Pi
Camera %d-%m-%Y %X" -o /home/pi/negative.
jpg
```

As you can see from the image above, this is an interesting effect! Be sure to try out the sketch and emboss commands too.

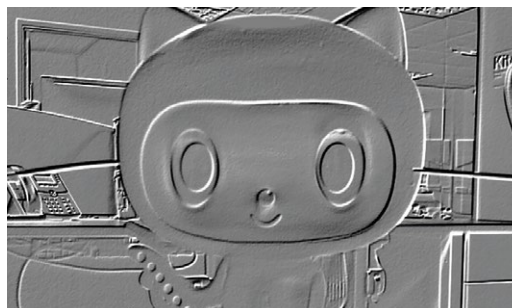
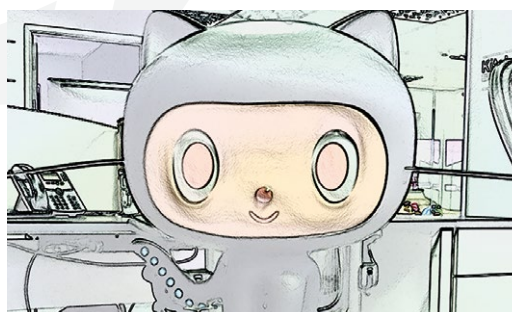

## Camera Essentials

We've only just scratched the surface of what the Camera Module can do in our guide, so why not take a look at *The MagPi Essentials Camera Module Guide* for a more comprehensive overview of all the commands, hints, and tips to ensure you get the most out of it?

[magpi.cc/camera-essentials](http://magpi.cc/camera-essentials)



◀ Make the photo look like a watercolour painting instead of a negative with the `-ifx watercolour` parameter

◀ Embossing is the process of creating a raised image, usually in paper or card. You can recreate the effect with the `-ifx emboss` parameter

# CAMERA MODULE PROJECTS

We've selected six Camera Module-related projects to try out. If you need some inspiration, then take a look at the pick of the bunch

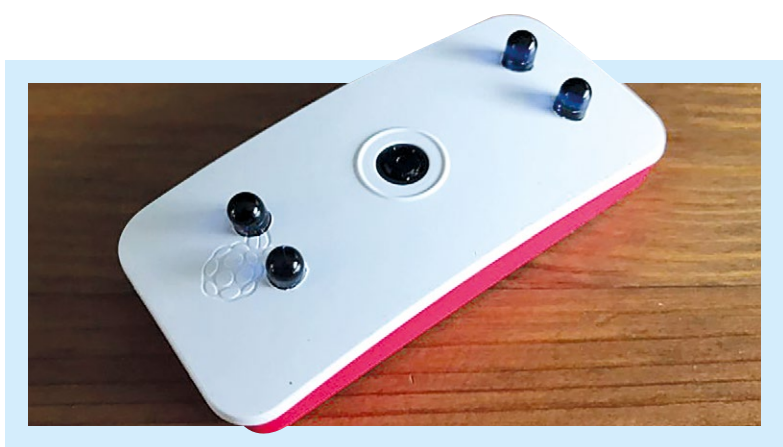

## Pi Zero LED case hack

As you now know, the NoIR version of the Camera Module has the infrared filter removed from the lens so that it can detect infrared light. This makes it an ideal choice for projects in the dark. In this neat project, you can easily add IR LEDs to provide additional infrared light, so that your pictures capture more detail in the dark – and all housed within the official Raspberry Pi Zero case, too!

[More info: magpi.cc/xCozST](https://magpi.cc/xCozST)

## Stop-motion animation

Stop-motion animation – think Wallace & Gromit – is where a series of photographs are taken, but with minor changes made to the ‘scene’ being filmed. The scene is changed slightly between shots – known as frames – and when they are all stitched back together afterwards, the illusion of animation is complete! In this fantastic tutorial, learn how to add a button to your Camera Module setup and create your very own stop-motion animation!

[More info: magpi.cc/KiYbdb](https://magpi.cc/KiYbdb)

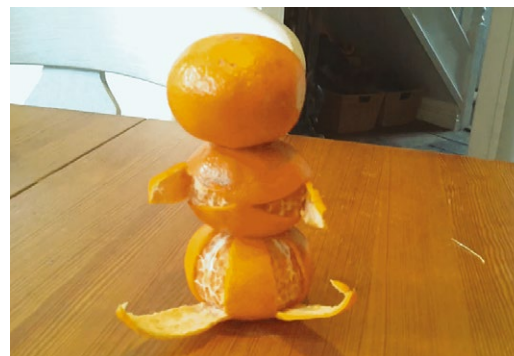

## Rodak: a Pi in a Kodak

Taking photos is what the Camera Module is designed for, so what better way to do that than to upcycle an old Kodak Brownie Flash III camera to house a Raspberry Pi Zero, like Alex Ellis did? It also contains some additional components, such as a LiPo battery for power-on-the-go, a push-button to trigger the camera, and a cool NeoPixel status LED to show you when the camera is ready to fire again!

[More info: magpi.cc/sAxjyc](https://magpi.cc/sAxjyc)





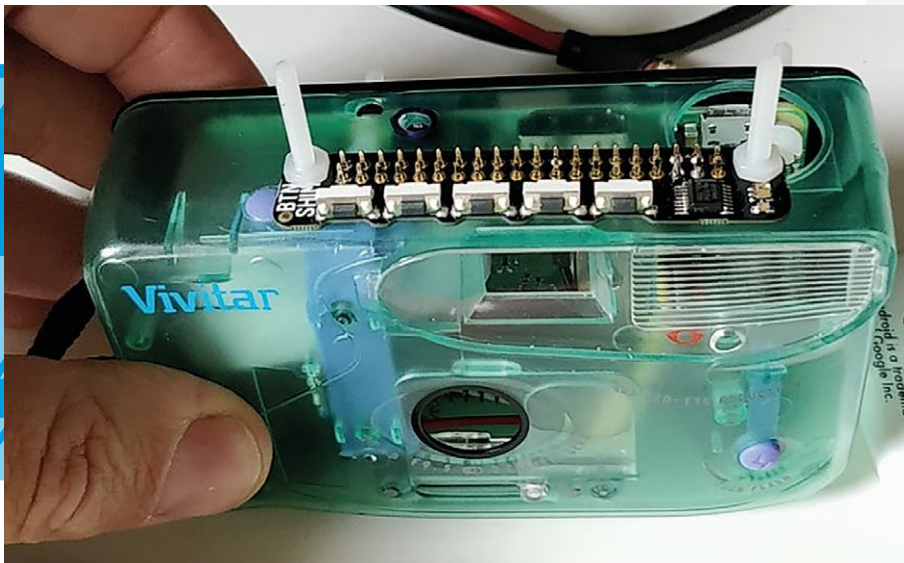

"Easily add IR LEDs to provide additional infrared light, so that your pictures capture more detail in the dark!"

### Google Vision: Camera Tell

This cool project, by Dan Aldred (aka TeCoEd), makes use of the Google Vision cloud service. If you haven't heard of Google Vision, it uses artificial intelligence to analyse an image and tells you what is in it! Dan takes this project even further by creating a portable camera – housed inside an old disposable camera – that uses a Camera Module, as well as Google Vision to announce what you have just taken a photo of.

**More info:** [magpi.cc/VadAHy](http://magpi.cc/VadAHy)



### Home CCTV with motionEyeOS

If you missed our Home Security feature in issue 73 ([magpi.cc/73](http://magpi.cc/73)), then you should definitely check out the handy motionEyeOS, which is a standalone operating system that runs on Raspberry Pi and allows you to easily create your very own home CCTV setup with a few clicks. Once the OS image is flashed to your microSD card, you will be up and running in no time and be able to keep an eye on your home when you are away.

**More info:** [magpi.cc/mpiLqjp](http://magpi.cc/mpiLqjp)



### Make a parent detector

Do you suspect your parents sneak into your room when you're out? Do they play on your Xbox or PS4 without your permission? Then follow this tutorial and build a parent detector, using the Camera Module and a PIR (passive infrared) sensor, and catch them red-handed! Learn how the PIR sensor can trigger the Camera Module to take a photo whenever it detects movement, then see how your parents react when confronted with the evidence.

**More info:** [magpi.cc/nlaODg](http://magpi.cc/nlaODg)

# Cube:Bit

► 4tronix ► [magpi.cc/PjGgkp](http://magpi.cc/PjGgkp) ► From £22 / \$24

Inspired by the Cubert project, this NeoPixel matrix can produce impressive 3D visual effects. **Phil King** sees the light

## SPECS

### PIXELS:

125 NeoPixels  
(5×5×5 model)

### DIMENSIONS:

89×89×89 mm  
(5×5×5 model)

### BASE I/O:

GPIO header,  
micro:bit  
connector,  
and others

Coming in three main size options – 3×3×3, 4×4×4, and 5×5×5 – the Cube:Bit is a 3D matrix of RGB NeoPixels. 4tronix tells us that the product was inspired by Lorraine Underwood’s Cubert project ([magpi.cc/djMRkX](http://magpi.cc/djMRkX)), although the Cube:Bit is a whole lot smaller than that giant creation. The 5×5×5 model (£90 / \$98) we tested measures 89 mm along each side.

First, however, you need to put it together, as it comes in 2D square ‘slices’ (supplied in a posh-looking jewellery-style box). Assembly is quick and fairly simple, following the online guide ([magpi.cc/EujyXH](http://magpi.cc/EujyXH)). Each slice is mounted on the one below using the supplied metal stand-off pillars and screws. You just need to be careful to flip each alternate slice (helpfully, they’re labelled A-side and B-side) and make sure the 5V and GND corners match, while the lower slice’s DOUT (data out) connects to the DIN on the one above. Only three pillars are used to connect each slice, since you don’t want to connect the lower slice’s DIN

to the upper one’s DOUT, so those corners have alternating missing pillars as you build up. Even so, the end result is a solid-feeling cube that you can carry around and even turn over in your hand without any worries about it falling apart.

## Power and control

While it’s possible to power and control the Cube:Bit manually – by connecting the metal stand-off ‘legs’ of the bottom slice to a 5V power supply, ground, and Raspberry Pi or microcontroller, using crocodile clips – it’s a lot easier to simply mount it (using stand-offs) on the optional Cube:Bit Base (£12 / \$13). The latter features four 5V power connection options: micro USB, 2.1 mm DC jack, GVS pins, and crocodile clip positions.

► The family of Cube:Bits, from 3×3×3 to 5×5×5

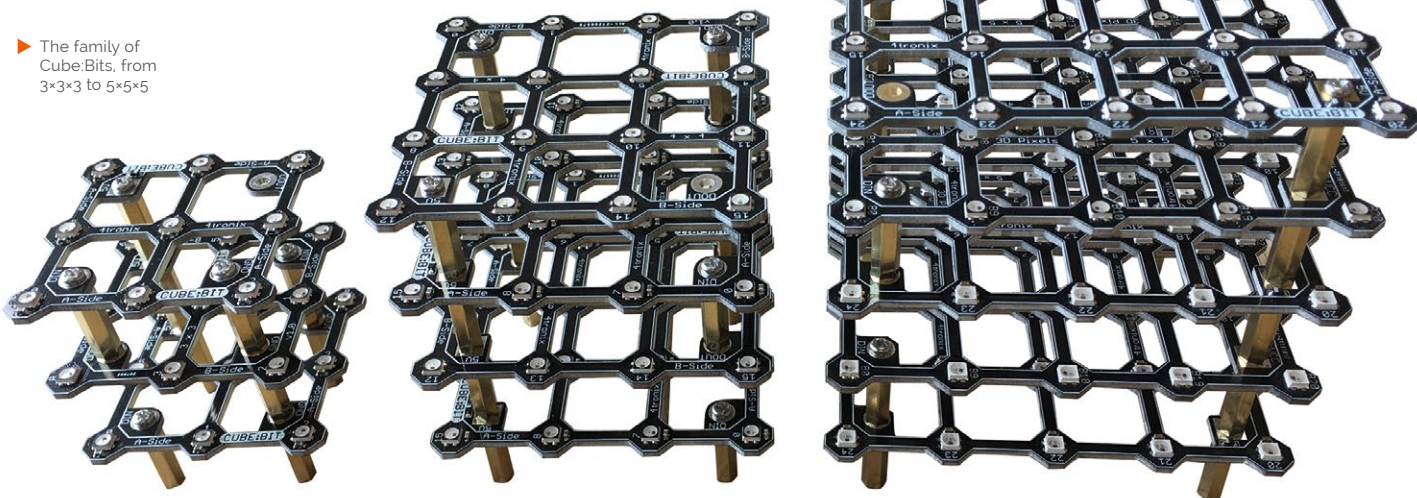



This will in turn power a connected Raspberry Pi or other microcontroller. Along with a micro:bit slot, there's a female GPIO header for Raspberry Pi. Note, however, that the nearby metal pillars prevent a full-size Pi model being mounted directly, so you'll need to use a ribbon cable (or jumper wires to 5V, GND, and GPIO 18 – the only pins used). A Pi Zero, however, can be mounted directly on the Cube:Bit Base header, albeit with the Zero's board sticking out of the side.

### Snaking pixels

In essence, the Cube:Bit is a string of NeoPixels, so you can control them with any standard WS2812B compatible code. On the Pi, this necessitates installing the `rpi_ws281x` Python library – directly or by using the curl script for Pimoroni's Unicorn HAT, for example.

▼ Stack 'em high! You can theoretically add as many extra slices as you want

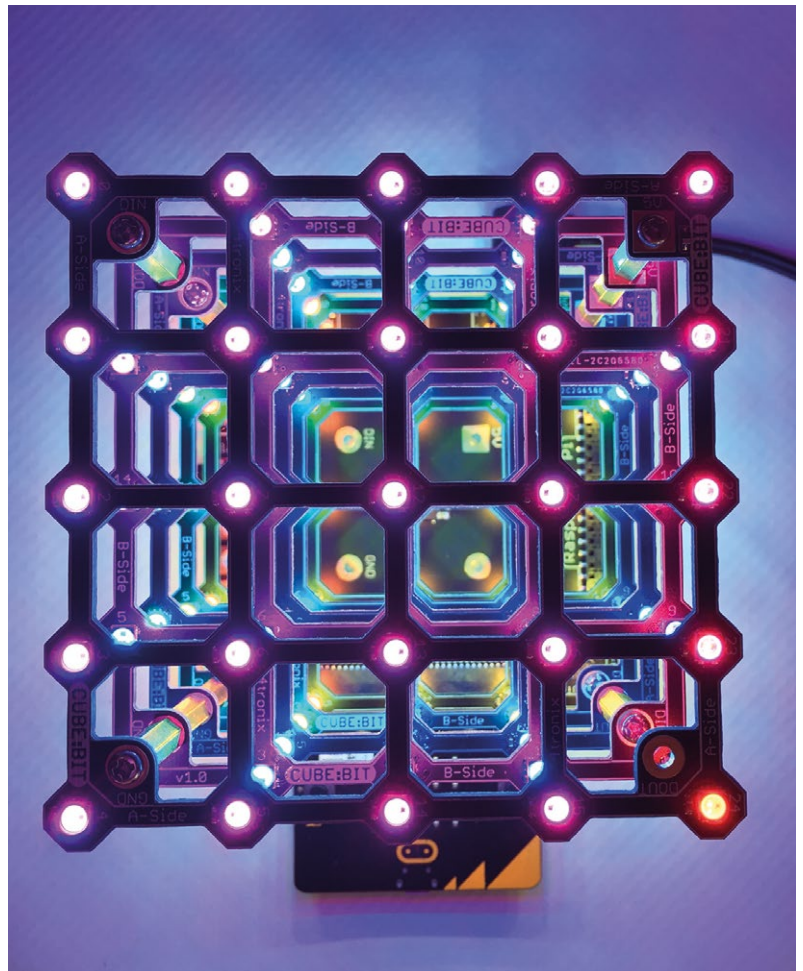
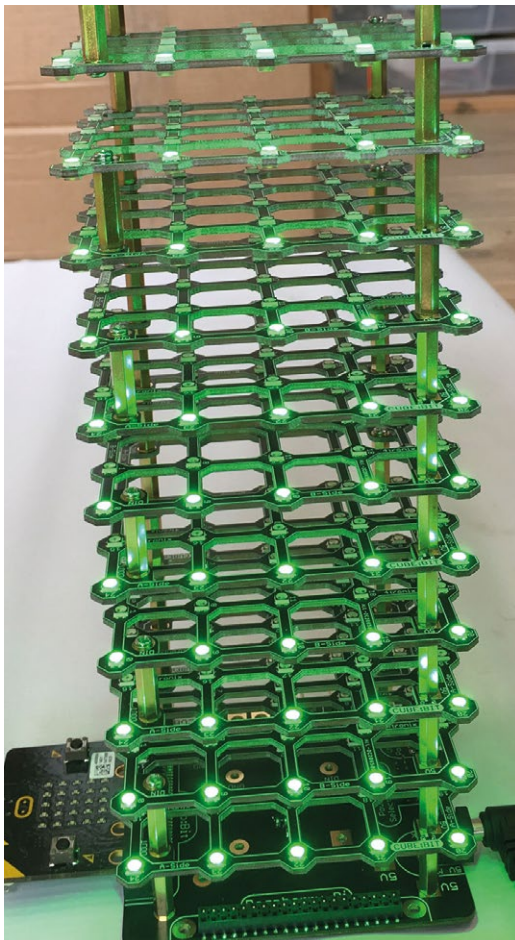

Since the 'string' of NeoPixels snakes up and down each slice before connecting to the one above, this would make controlling them manually rather mind-boggling. Fortunately, 4tronix has created a Python library which can be downloaded with a one-line Terminal command. This maps the pixels logically so that you can easily address them with x, y, and z coordinates. So it might even be a useful aid for educators teaching 3D geometry.

At the time of writing, the Python library only came with a couple of code examples: **test.py** for a rainbow effect and individual pixel test, and **purpleRain.py** which sees purple 'raindrops' falling from the top to the bottom of the cube. The micro:bit has a larger range of MakeCode examples to show what Cube:Bit can do, including effects based on rotating the cube (possibly achievable using an Enviro pHAT or similar on the Pi).

We also thought of using it as a fancy VU meter for music. Going one step further, Robin Newman has created a project with the Cube:Bit LEDs controlled from Sonic Pi using OSC messages ([magpi.cc/RkxuDU](http://magpi.cc/RkxuDU)) and even via a smartphone app. So there are plenty of possibilities. **M**

▲ The multicoloured matrix produces some dazzling displays

## Verdict

Easy to assemble, if not quite so simple to program, the Cube:Bit is pricey for the larger sizes – with the Base costing extra – but can produce some unique 3D visuals.

# 8/10

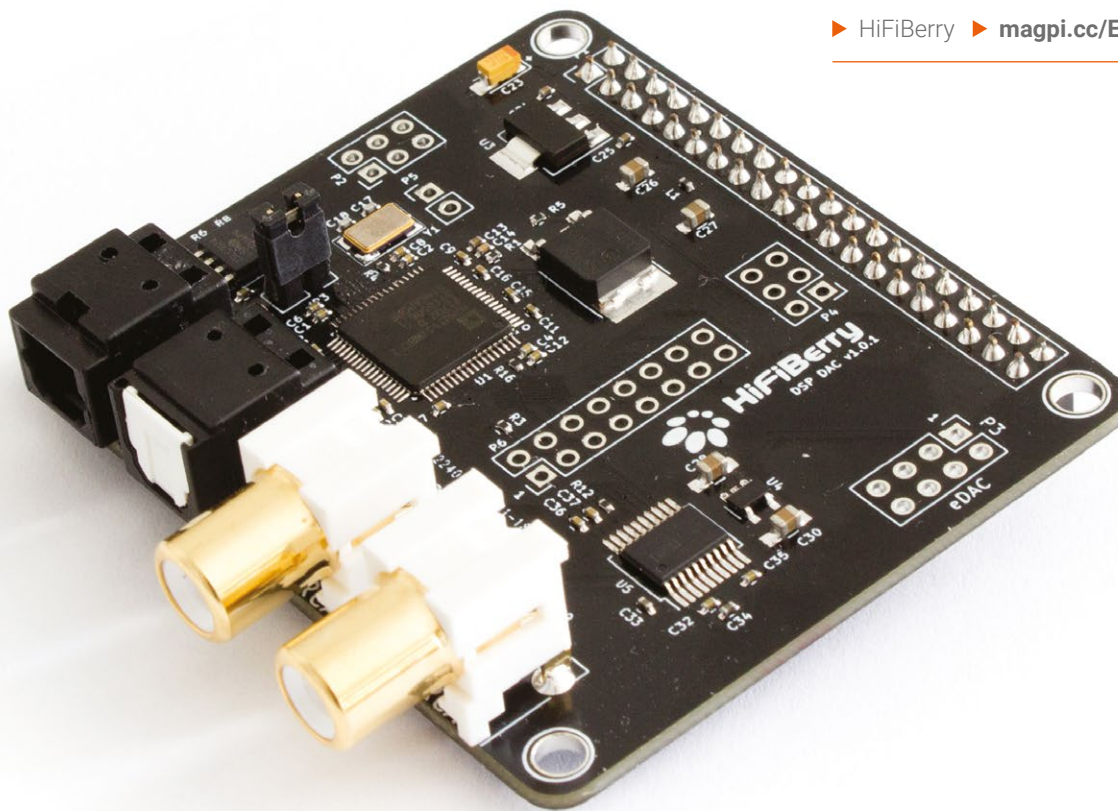

## SPECS

**ANALOGUE OUTPUT:**  
2 × RCA

**DIGITAL I/O:**  
Input up to 96kHz, output up to 192kHz

**DSP:**  
300MHz

**SAMPLE RATE CONVERSION:**  
Asynchronous sample rate converter

**OTHER:**  
EEPROM

# DAC+ DSP

Upcycle old speakers and add smarts to an analogue stereo with powerful digital signal processing. By **Lucy Hattersley**

**H**iFiBerry's new DAC+ DSP hopes to take Raspberry Pi audio to another level, bringing digital signal processing (DSP) to a reasonably priced DAC (digital-to-analogue converter).

Regular readers may notice that it bears a lot of similarity to the recent Beocreate board (reviewed in *The MagPi* #72, [magpi.cc/72](https://magpi.cc/72)). The DAC+ DSP has much of the technology from the more expensive Beocreate (£149), but with only two RCA outputs (as opposed to the Beocreate's four).

## Wired for sound

We found setup relatively straightforward. The board attaches directly to the GPIO pins of a Raspberry Pi 2/3 or Pi Zero, from which it draws its power. We tested it out with a Pi Zero W.

OSMC works right out of the box and LibreELEC required a one-line tweak to the `config.txt` file. HiFiBerry hadn't got the online documentation up during our review, but it has detailed setup guides for all its other products and we found following the regular DAC+ guide good enough to get going.

DSP is where things get interesting. You can affect the digital audio output, adding your own customisations and effects with code.

HiFiBerry has a GitHub repository with a range of software options for DSP boards ([magpi.cc/bzizRQ](https://magpi.cc/bzizRQ)). One interesting option is

“ You can affect the digital audio output, adding your own customisations and effects with code ”

to use REW (Room EQ Wizard, [roomeqwizard.com](https://roomeqwizard.com)) software to analyse the acoustics in your room ([magpi.cc/xJaOiu](https://magpi.cc/xJaOiu)).

You can also set up a speaker crossover; this takes the single digital input signal and creates multiple output signals of high-, mid-, and low-range frequencies that can be tweaked ([magpi.cc/gbvAXa](https://magpi.cc/gbvAXa)). ”

## Verdict

We like this board a lot. It offers all the joy of a high-end DAC with an additional layer of coding for digital audiophiles.

8/10



# HackSpace

TECHNOLOGY IN YOUR HANDS

THE **NEW** MAGAZINE  
FOR THE **MODERN MAKER**



SUBSCRIBE AND  
**SAVE UP TO**  
**35%**  
on the cover price



ISSUE #12  
**OUT NOW**

[hsmag.cc](http://hsmag.cc)



# 10 Best:

## Raspberry Pi Starter Kits

New to Raspberry Pi? Here are some essential beginner's kits...

**W**hen you first get a Raspberry Pi, there are always a few things you need to get to go with it. A microSD card, cables, keyboards, electronics components, etc. With these starter kits, you can kick-start your learning with Raspberry Pi. 



### Official starter kit

**TYPE:** Simple and clean

This smart starter kit from Raspberry Pi includes a Raspberry Pi 3, as well as an official power supply, case, mouse, and keyboard. You even get Carrie Anne Philbin's excellent book, *Adventures in Raspberry Pi*, to start your Pi journey with.

- ▶ £119 / \$140
- ▶ [magpi.cc/DLrEkB](http://magpi.cc/DLrEkB)



### Raspberry Pi 3B+ essentials kit

**TYPE:** Just the essentials

This kit also comes with a Raspberry Pi, a slimmed-down Pibow case, a power supply, and a microSD card. The very essentials you'll need to get your Raspberry Pi running – along with a free Pi sticker.

- ▶ £58 / \$63
- ▶ [magpi.cc/PVrMLf](http://magpi.cc/PVrMLf)

### Retro Gaming Kit

**TYPE:** Retro fun

A lot of people love to use their Raspberry Pi to play retro games on, and this kit is specifically designed to help you quickly make a great-looking Pi-powered console. The NES-style case is a nice touch.

- ▶ £76 / \$102
- ▶ [magpi.cc/RmLPCn](http://magpi.cc/RmLPCn)



### Raspberry Pi 3 B+ Starter Kit

**TYPE:** A bigger kit

This bigger starter kit from Pimoroni includes a keyboard, mouse, stickers, a Blink! light strip, and a getting started guide! It's a nice beginner's kit that comes in a very pretty box, and those stickers are very important.

- ▶ £90 / \$98
- ▶ [magpi.cc/TGNWLY](http://magpi.cc/TGNWLY)



### Media Center Kit

**TYPE:** Improve your TV

As popular as retro gaming is on the Pi, home theatre PCs and media centres are even more popular among the community. This kit comes with all the essentials to get your HTPC Pi going, along with a lovely remote to control it all with.

- ▶ £76 / \$102
- ▶ [magpi.cc/SUByDV](http://magpi.cc/SUByDV)







## GoPiGo3

**TYPE:** Robot for beginners

While not the cheapest robot kit around, we think this is one of the best robot starter kits, with plenty of resources to learn how to use robots available for it as well. You can then use the base to make bigger and better robots.

- ▶ £76 / \$100
- ▶ [magpi.cc/iGqLbs](http://magpi.cc/iGqLbs)

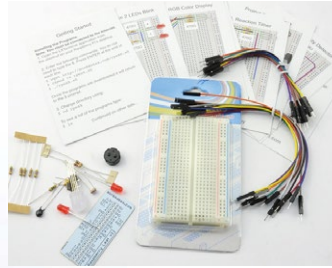

## Raspberry Squid combo pack

**TYPE:** A simple kit

We really like this kit from Monk Makes as it's a good introduction to electronics on the Raspberry Pi, which means it deserves a place on this list for people looking to get their start in using the (sometimes) mysterious GPIO pins on their Pi.

- ▶ £10 / \$15
- ▶ [magpi.cc/LdhiFy](http://magpi.cc/LdhiFy)



## Electronics Starter Kit

**TYPE:** More electronics fun

If you want to go beyond the Raspberry Squid, this kit opens up a whole world of basic electronics for you to experiment with. Each kit also comes with a load of quick projects printed on cards, with handy circuit diagrams to follow as well!

- ▶ £13 / \$18
- ▶ [magpi.cc/BdmsoY](http://magpi.cc/BdmsoY)

## pi-top

**TYPE:** All-in-one

Quite an extreme concept of a starter kit, the pi-top is a laptop you build yourself that uses a Raspberry Pi at its core. You get power, a screen, a keyboard, and a mouse along with the Pi, and it's even got a chargeable battery so it's portable. There's plenty of learning software on it as well!

- ▶ £260 / \$320
- ▶ [pi-top.com](http://pi-top.com)

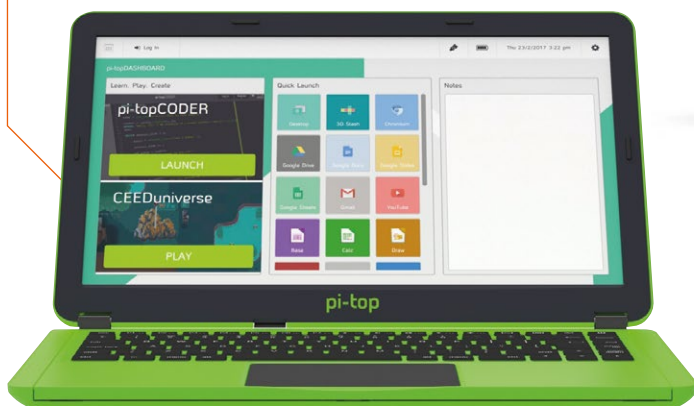

## The official Raspberry Pi Beginner's Book

**TYPE:** Kit and book

This is not just a book full of excellent tutorials to get your started on your Pi journey— it's also a Pi Zero kit! It comes with a Pi Zero W, adapter cables, a preloaded microSD card, and a case!

- ▶ £25 / \$33
- ▶ [magpi.cc/FESHGb](http://magpi.cc/FESHGb)



## FREE RESOURCES

There are loads of free tutorials on the Raspberry Pi website ([rpf.io](http://rpf.io)), along with all the free back issues of *The MagPi* on our site ([magpi.cc](http://magpi.cc)), which you can use to learn everything you need to know about the Pi!

# Learn Minecraft with Raspberry Pi

David Crookes looks at the resources that help you find your way around this sandbox video game

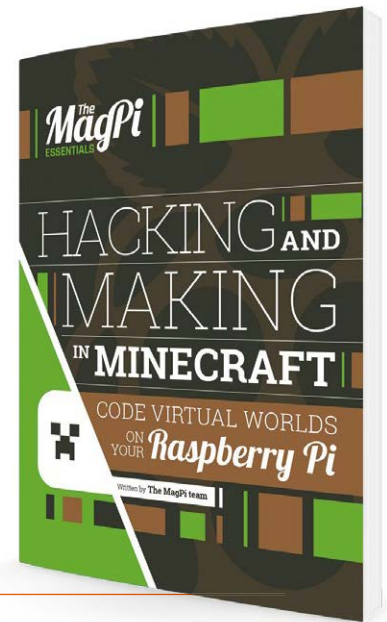

## Hacking and Making in Minecraft

**AUTHOR** The MagPi team  
 Price: £3.99 (Free download)  
[magpi.cc/minecraft-book](http://magpi.cc/minecraft-book)

Minecraft takes on a life of its own with a Raspberry Pi, thanks to it coming with an API. This allows you to create mods that link the game to the real world. It also lets you manipulate the structure using Python scripts, opening up a host of potential hacks.

For a solid grounding in such matters, this entry in *The MagPi Essentials* collection is a blockbuster. It helps to

quickly build confidence, briefly introducing the basics of the game and how to get started before moving you straight into your first program and the fundamentals of the API.

As well as understanding how to control and change any block, you'll learn how to code mini-games – including a fun two-player blast based on Nintendo's *Splatoon*. The book also covers the terraforming process that

lets you create an entire world from a favourite block and the ability to play God by sparking a host of natural disasters.

More than that, you'll be taught ways of making use of a Sense HAT, the GPIO pins, Sonic Pi, and JavaScript, all clearly and concisely explained. To aid your learning, there's a handy reference guide and annotated diagrams at the right moments. It's sure to level you up fast. 

## Coding tutorials

Understand how to program virtual worlds

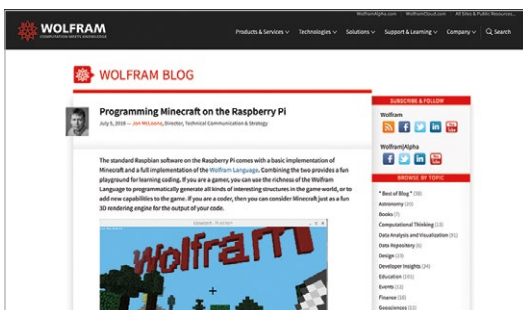

▲ Use Python or Wolfram Language to create things in Minecraft

### HOW TO PROGRAM MINECRAFT ON A RASPBERRY PI

This tutorial explores Minecraft: Pi Edition's sole playing mode – Classic – and encourages you to write a 'Hello World' program that can be adapted to transport Steve around the world.

► [magpi.cc/tUJpeB](http://magpi.cc/tUJpeB)

### PROGRAMMING MINECRAFT WITH WOLFRAM LANGUAGE

With this tutorial from the Wolfram blog, you can learn how to combine

Minecraft and the Wolfram Language to create in-game structures that you can then look at from the air.

► [magpi.cc/CTMkgz](http://magpi.cc/CTMkgz)

### BUILD A HOUSE IN MINECRAFT USING PYTHON

This tutorial, taken from issue 68 of this very magazine, explains how you can design and build a house using Python. It comes with links to the project's complete code.

► [magpi.cc/xQwLLb](http://magpi.cc/xQwLLb)



# Getting started with Minecraft

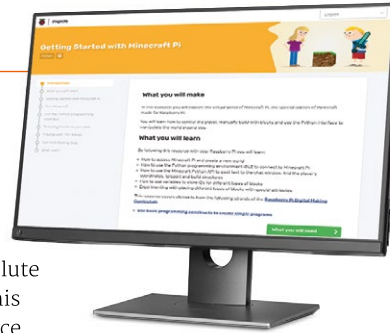

**AUTHOR**

**Raspberry Pi Foundation**

Price: Free  
[magpi.cc/DgJMOe](http://magpi.cc/DgJMOe)

Don't worry if you're an absolute Minecraft newbie, because this well-explained online resource certainly has you covered. It leads you by the hand to ensure that your first steps in the game are as painless as possible and, by splitting the guide over nine approachable sections, each lesson has the right amount of information without feeling overwhelming.

The first four tutorials concentrate on installing the game and explaining the basics of gameplay. The next four

plunge you into the Python programming interface where each command and block of code is helpfully highlighted and breezily explained.

We like that it avoids overcomplicating matters and that results are seen on-screen at every step. Ending with tips on how you can use your knowledge, it's sure to whet your appetite for more. **M**

# YouTube Videos

Learn tricks via short video courses

## GETTING STARTED CODING MINECRAFT PI

Carrie Anne Philbin's gentle and informative introduction to hacking Minecraft using Python is delightfully easy to follow thanks to an exhaustive approach that explains and shows each step in detail.

► [magpi.cc/zvXssK](http://magpi.cc/zvXssK)

## MINECRAFT PI EDITION - SURVIVAL MODE & PYTHON SCRIPTS

Although poorly presented and spending large chunks in silence, this inspiring video is nevertheless educational, covering a Survival Mode mod while linking to Python scripts and assets in the description.

► [magpi.cc/dsMPqC](http://magpi.cc/dsMPqC)

## HACKING MINECRAFT PI EDITION

Superbly fronted with dollops of humour, this extremely approachable guide explores Python coding and the basics of the Minecraft API, with lots of nods to extra resources and further information.

► [magpi.cc/dhuRid](http://magpi.cc/dhuRid)

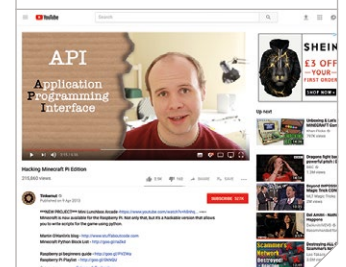

# Minecraft quick-start guide and wiki

**AUTHOR**

**Raspberry Pi Foundation**

Price: Free  
[magpi.cc/VUUMpL](http://magpi.cc/VUUMpL)  
[magpi.cc/qEzamd](http://magpi.cc/qEzamd)

Visit the official Minecraft website and, as well as being able to download a free copy of the game, you can access the Raspberry Pi quick-start guide and Minecraft wiki.

The former shows you the hardware and software needed to get Minecraft Pi up and running. The latter, however, is a mine of information and one to bookmark for future use, particularly so for the handful of references at the end and, crucially, the details listed under Gameplay.

Here you can find out how each block, tool, and plant works within the game, along with items that only work if modded. You can also discover any limitations, both within the elements themselves and the Pi version of Minecraft. Fully editable and expandable, it should go some way to answering your questions. **M**





THE Official  
**RASPBERRY PI**  
**PROJECTS BOOK**

VOLUME 4

**200 PAGES OF  
 IDEAS & INSPIRATION**

THE OFFICIAL RASPBERRY PI PROJECTS BOOK VOLUME 4



DIY Games Console



Build a Robot



Set up a Spy Cam



Make a Magic Mirror

**55 PROJECTS & GUIDES**

FROM THE MAKERS OF *The MagPi* THE OFFICIAL RASPBERRY PI MAGAZINE

200 pages of Ideas & Inspiration



**£12.99**  
200 pages of  
**Raspberry Pi**

THE *Official*

# RASPBERRY PI PROJECTS BOOK

VOLUME 4

Amazing hacking and making projects  
from the makers of *MagPi* magazine

## Inside:

- How to get involved with the Pi community
- The most inspirational community projects
  - Essential tutorials, guides, and ideas
  - Expert reviews and buying advice

Available  
now

[magpi.cc/store](http://magpi.cc/store)

plus all good newsagents and:

WHSmith **BARNES&NOBLE**

Available on the  
**App Store**

GET IT ON  
**Google Play**



# Dave Honess

Taking education to the stars with Space Dave

- Category **Educator** | ➤ Website **[www.esa.int](http://www.esa.int)**
- Day job **ISS and International Education Operations Coordinator**

**“M**y earliest memory of being interested in space was watching Halley’s Comet as a nine-year-old,” Dave Honess tells us. We know Dave personally – he used to work at the Raspberry Pi Foundation as the man behind Astro Pi, and he’s even written a couple of tutorials in the magazine.

These days, Dave works with the European Space Agency (ESA) to help organise their

educational programs, and liaises with current Astro Pi programs at the Foundation.

“Most of my career had nothing to do with space,” Dave admits. “But I always maintained an interest and enjoyed watching the ISS live streams in the early noughties when it was still being built. I never even imagined that the space industry could be a place where I might work one day; it always seemed so distant and abstract.”

Dave started working for the Raspberry Pi Foundation in early 2014, and soon found himself talking to folks from the UK Space Agency about a collaboration that eventually became the first Astro Pi mission.

“A friend working at ESA in the Netherlands told me he was changing jobs and that his position was going to become vacant.” Dave said. “We spent about an hour on the phone

▶ The first Astro Pi mission involved ESA Astronaut Tim Peake

Image Credit: ESA (European Space Agency)





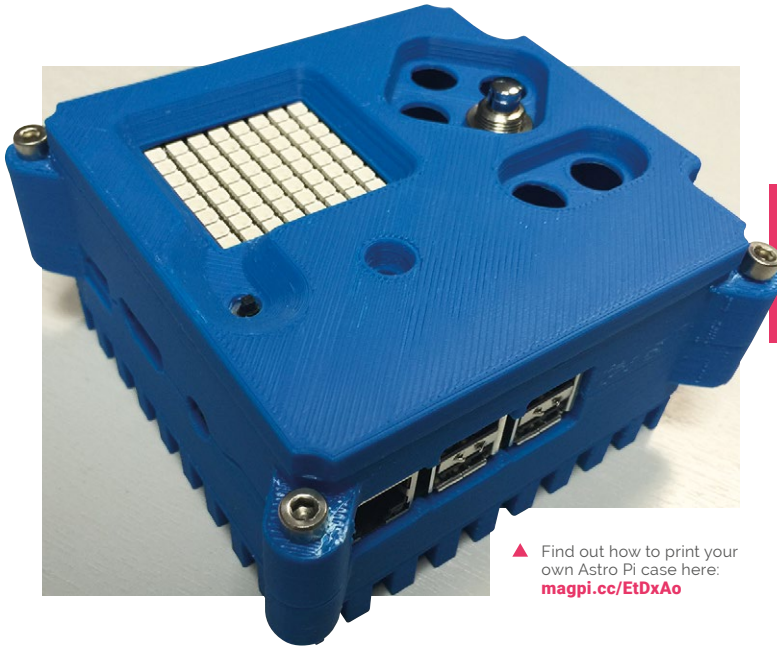

▲ Find out how to print your own Astro Pi case here: [magpi.cc/EtDxAo](http://magpi.cc/EtDxAo)

discussing all aspects of the work and... I decided to apply for the job. We have now moved to the Netherlands, and I have been working at ESA ESTEC [European Space Research and Technology Centre] since March 2018.”

### What's your favourite memory of working in the intersection of space and education?

“It's hard to pick just one. I'm really grateful to my former colleagues at the Raspberry Pi Foundation for allowing me to travel to Florida to watch the OA-4 rocket launch at Kennedy

Space Center in 2015 (the one carrying the original Astro Pi hardware to the ISS). I have strong memories of talking to the kids that have participated in Astro Pi, and hearing them say they now want to study aeronautics or astrophysics and suchlike.”

### Do you have any personal space-related plans?

“I do, actually. Every year, ESA organises a staff trip to French Guiana to see the Ariane launch facility; you have to fund the flights yourself, but you'll get

## Astro Pi

Hopefully you know by now that there are two special Raspberry Pi boards up on the International Space Station. Named Ed and Izzy, these two Astro Pi devices are designed to perform different kinds of experiments on the ISS: Ed lives in the Columbus module and uses a normal Camera Module, while Izzy has an IR Camera Module that looks out of a porthole down onto Earth.

There are regular competitions for European schoolchildren to get their experiments run on these computers, with a couple even running right now! Head to [astro-pi.org](http://astro-pi.org) for more details.



access to the launch site and a guided tour. If you're lucky, you also get to see an integrated launch vehicle sitting on the pad, and if you're really lucky your visit might coincide with an actual launch.”

### Any future work-related plans you can share with us?

“I'm actually starting to believe that computing education is getting to a really good place now, not to say that we should take our foot off the pedal or anything. Astro Pi has developed into a mature educational challenge and I think it will go from strength to strength. I'm now turning my attention a little towards amateur radio, which is something that definitely doesn't have the uptake it needs. Radio remains the only way to communicate with all our spacecraft throughout the solar system, and organisations like ARISS and local HAM radio clubs are, in my opinion, becoming more and more necessary to attract new talent. It would be good to see educational material joining computing and radio topics. After all, all spacecraft can be boiled down to two main components: a computer and a radio!” 

▼ This is Izzy the Astro Pi – its camera looks out of a window of the ISS

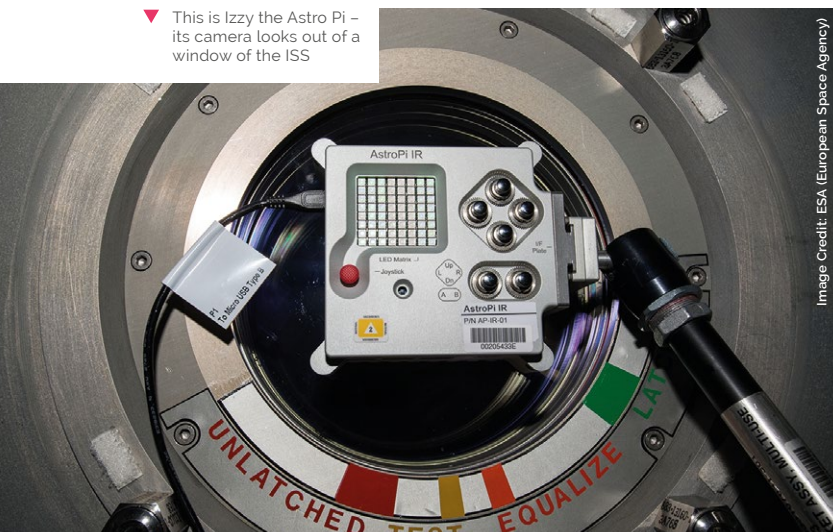
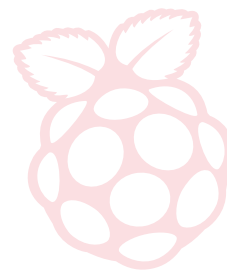



Image credit: ESA (European Space Agency)



# This Month in Raspberry Pi

## World Maker Faire New York 2018

Makers galore at the annual World Maker Faire!

Last year you may remember that we went out with the Raspberry Pi Foundation to help out at their stall, getting young makers started with their maker journey through some fun Pi projects. While there was no official Raspberry Pi stall at World Maker Faire this year, that doesn't mean there weren't plenty of amazing makers there, and many of them were using a Raspberry Pi in their projects. Take a look! 

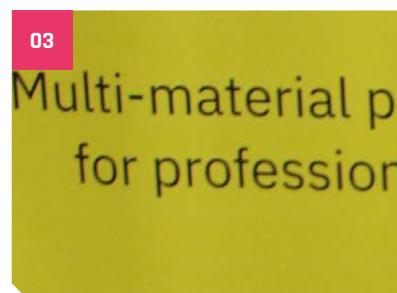

- 01. There were talks galore
- 02. Do not feed this Seymour puppet
- 03. Amazing 3D prints
- 04. Some of the robots were very big
- 05. This mini Landspeeder is perfect for popping down to Tosche Station
- 06. Raspberry Pi didn't have a booth, but team members were still present

Credit: Lenore Edman





# Announcing the Raspberry Jam Big Birthday Weekend 2019!



Celebrate the birthday of Raspberry Pi at your local Jam!

For Raspberry Pi's birthday this year, the Foundation coordinated over 100 community-led Raspberry Jam events around the globe. In a few months' time, Raspberry Pi will be seven years old – and to celebrate, they're hosting another Big Birthday Weekend, which takes place all over the world on 2–3 March 2019.

“Last year's event was a lot of fun!” Ben Nuttall, Raspberry Pi Community Manager, wrote on the Raspberry Pi blog. “We sent out starter kits and extra birthday goodies to participating Jams, and even put together a tweeting Raspberry Pi photo-booth for people to set up to share their events.”

With the incredible support of the Raspberry Pi community, the Pi's birthday was able to be celebrated in 40 countries, covering six continents – that is, every continent except Antarctica! Members of the Raspberry Pi Foundation team joined in with events in the UK, in California, across Europe, and elsewhere, despite unexpected UK snow-storms.

## Get involved

If you'd like to run an event for our Big Birthday Weekend, please head over to the Big Birthday Weekend 2019 page ([magpi.cc/CrMUru](http://magpi.cc/CrMUru)) and sign up for the newsletter. That's where updates will be provided on what's going on and what you need to do to join in.

If this sounds like it might be your kind of thing, but you've never done it before, there's plenty of time to get off to a gentle start and run a Jam before 2018 is out. When you join the newsletter, an invitation will be sent to you for the Jam maker Slack community, where you can get support from the Raspberry Pi Foundation and from wonderful Jam makers all around the world. They have lots of help and advice to offer people who are just starting out with their first Jam, and you'll be well rehearsed by the time the Birthday Weekend comes around. 



## JAM GUIDEBOOK

Not sure where to start running your own Jam? A handy free guidebook all about setting up a Raspberry Jam can get you started. Head here to grab the PDF: [magpi.cc/2qDHFQ](http://magpi.cc/2qDHFQ)





# Crowdfund **this!** Raspberry Pi projects you can crowdfund this month



## HackerTab Pro

"This is not a kit, it is a fully assembled professional tablet for industrial and field use," states the Kickstarter page for the HackerTab Pro. It's a Compute Module 3-powered tablet that you'll be able to buy for €249 (£219/\$287) and the makers reckon you'll be able to use it in industrial settings, as well as for retro gaming or an in-car computer. It looks pretty snazzy, too.

► [kck.st/2pCngHr](https://kck.st/2pCngHr)



## CROWDFUNDING A PI PROJECT?

If you've launched an irresistible Pi-related project, let us know!  
[magpi@raspberrypi.org](mailto:magpi@raspberrypi.org)

## ITX & Raspberry Pi Retro Keyboard Computer Case

We love seeing these sort of projects that create very retro-style cases for the Pi. The FUZE also does a similar thing, bringing the look of the BBC Micro to the Raspberry Pi. It's very apt, as the Pi was inspired by the Micro. This project is made out of PVC and comes as a kit that you can build yourself, or a more complete package.

► [magpi.cc/iTpMgJ](https://magpi.cc/iTpMgJ)

## Best of the rest! Here are some other great things we saw this month

### RASPBERRY PI ETCH A SKETCH

This is extremely fun – motors controlled by a Raspberry Pi turn the knobs on an Etch A Sketch classic toy. With a bit of hacking and programming, maker Sunny Balasubramanian managed to get the Pi to break down images sent to it into instructions to draw it on the toy.

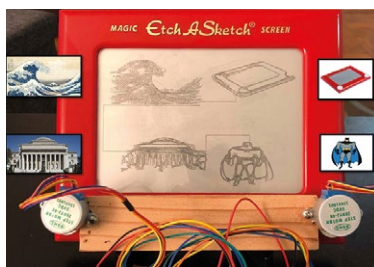

► [magpi.cc/wuLzXa](https://magpi.cc/wuLzXa)

### ROTATING VIDEO SCREEN

The Pi doesn't have a built-in gyroscope, so, unlike a smartphone, you can't tilt it to change the orientation of a mounted mini display. This project takes the concept and goes a step further, with video that is constantly playing at a specific orientation as you move the Pi around. It's magic.

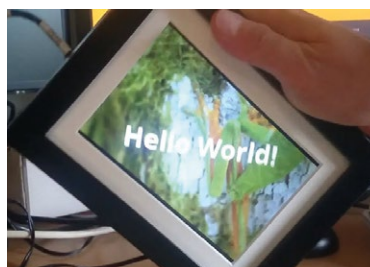

► [magpi.cc/HrwPdB](https://magpi.cc/HrwPdB)

### SMARTER MIRROR

It takes something a bit different to get us to pay attention to a new magic mirror: there are so many of them! However, this build – which includes useful hooks for storing keys, and a charging station – makes it a lot more useful than others!

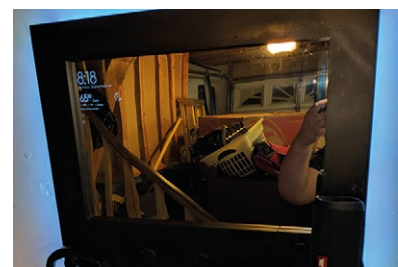

► [magpi.cc/tZDPyp](https://magpi.cc/tZDPyp)

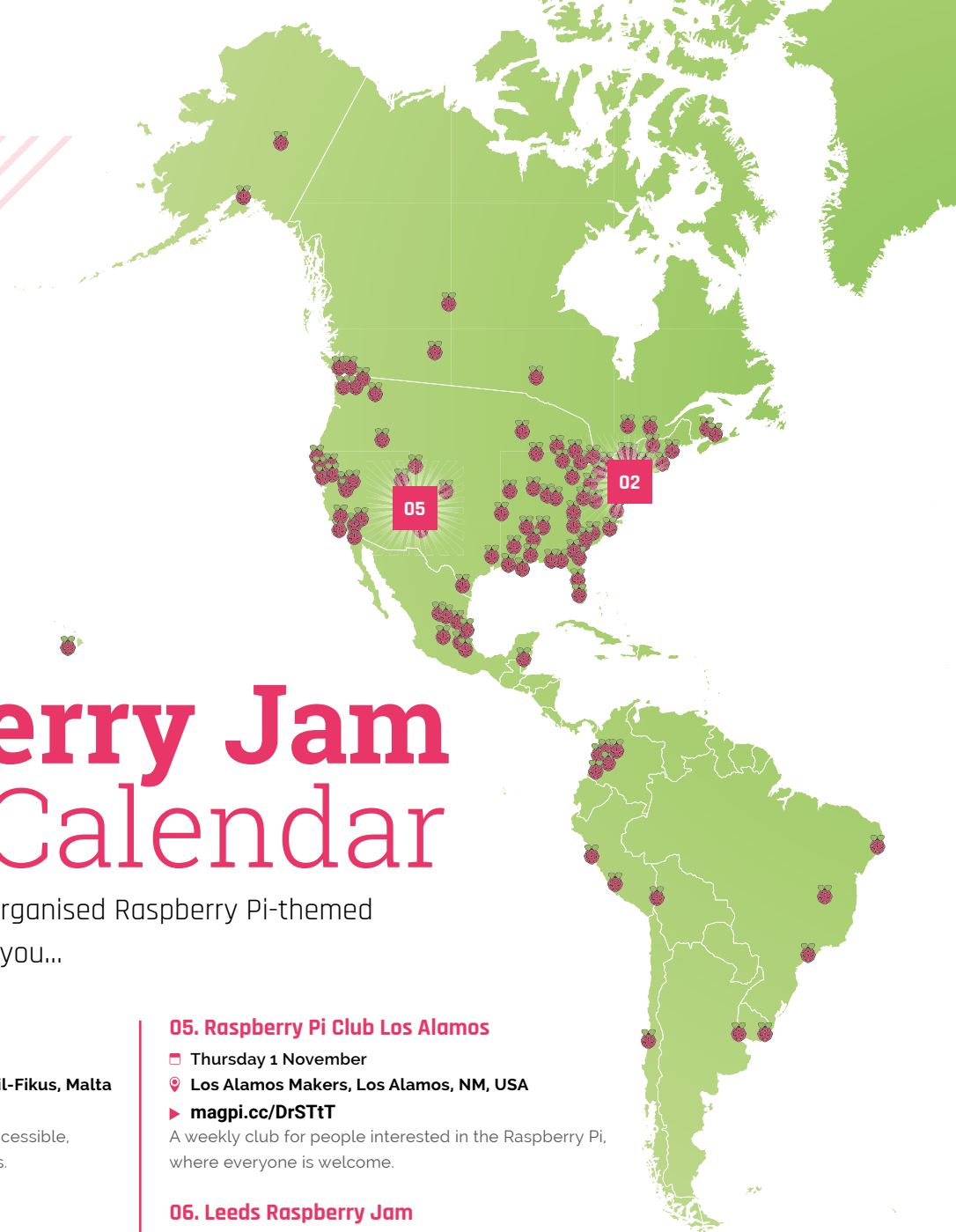

# Raspberry Jam Event Calendar

Find out what community-organised Raspberry Pi-themed events are happening near you...

## 01. MaltaPi

- 📅 Saturday 3 November
- 📍 Vintage Computer Club Malta, Triq il-Fikus, Malta
- ▶ [magpi.cc/pTtuXW](http://magpi.cc/pTtuXW)

This weekend-long event is free and accessible, with room to show off your own projects.

## 02. STEM Raspberry Pi for kids

- 📅 Saturday 3 November
- 📍 Silver Spring Library, Silver Spring, MD, USA
- ▶ [magpi.cc/CKhMOq](http://magpi.cc/CKhMOq)

For folks living in Maryland and Washington DC, there will be several STEM classes related to Pi.

## 03. Pi and More

- 📅 Saturday 3 November
- 📍 Universität Trier, Trier, Germany
- ▶ [piandmore.de](http://piandmore.de)

Beginners and experts meet in a relaxed atmosphere for talks, workshops, and projects focusing on Pi.

## 04. Thorpe Raspberry Jam

- 📅 Saturday 3 November
- 📍 Thorpe St Andrew School, Thorpe St Andrew, UK
- ▶ [magpi.cc/jTCeUi](http://magpi.cc/jTCeUi)

Thorpe Jam is back, with show-and-tells, electronics workshops, and more.

## 05. Raspberry Pi Club Los Alamos

- 📅 Thursday 1 November
- 📍 Los Alamos Makers, Los Alamos, NM, USA
- ▶ [magpi.cc/DrSttT](http://magpi.cc/DrSttT)

A weekly club for people interested in the Raspberry Pi, where everyone is welcome.

## 06. Leeds Raspberry Jam

- 📅 Wednesday 7 November
- 📍 Dixons Unity Academy, Leeds, UK
- ▶ [magpi.cc/abNdVn](http://magpi.cc/abNdVn)

Get hands-on with more digital making activities through the workshop, and a hackspace area to share projects.

## 07. Raspberry Jam Cambridge

- 📅 Saturday 10 November
- 📍 Sancton Wood School, Cambridge, UK
- ▶ [magpi.cc/mXsjmA](http://magpi.cc/mXsjmA)

A great way to meet other makers and learn something new. Sessions are classroom based and run hourly.

## 08. Raspberry Jam @ Pi Towers

- 📅 Saturday 10 November
- 📍 37 Hills Road, Cambridge, UK
- ▶ [magpi.cc/HDikif](http://magpi.cc/HDikif)

Visit the new Raspberry Pi offices for the November Raspberry Jam @ Pi Towers!

## FULL CALENDAR

Get a full list of upcoming events for October and beyond here:

[rpf.io/jam](http://rpf.io/jam)



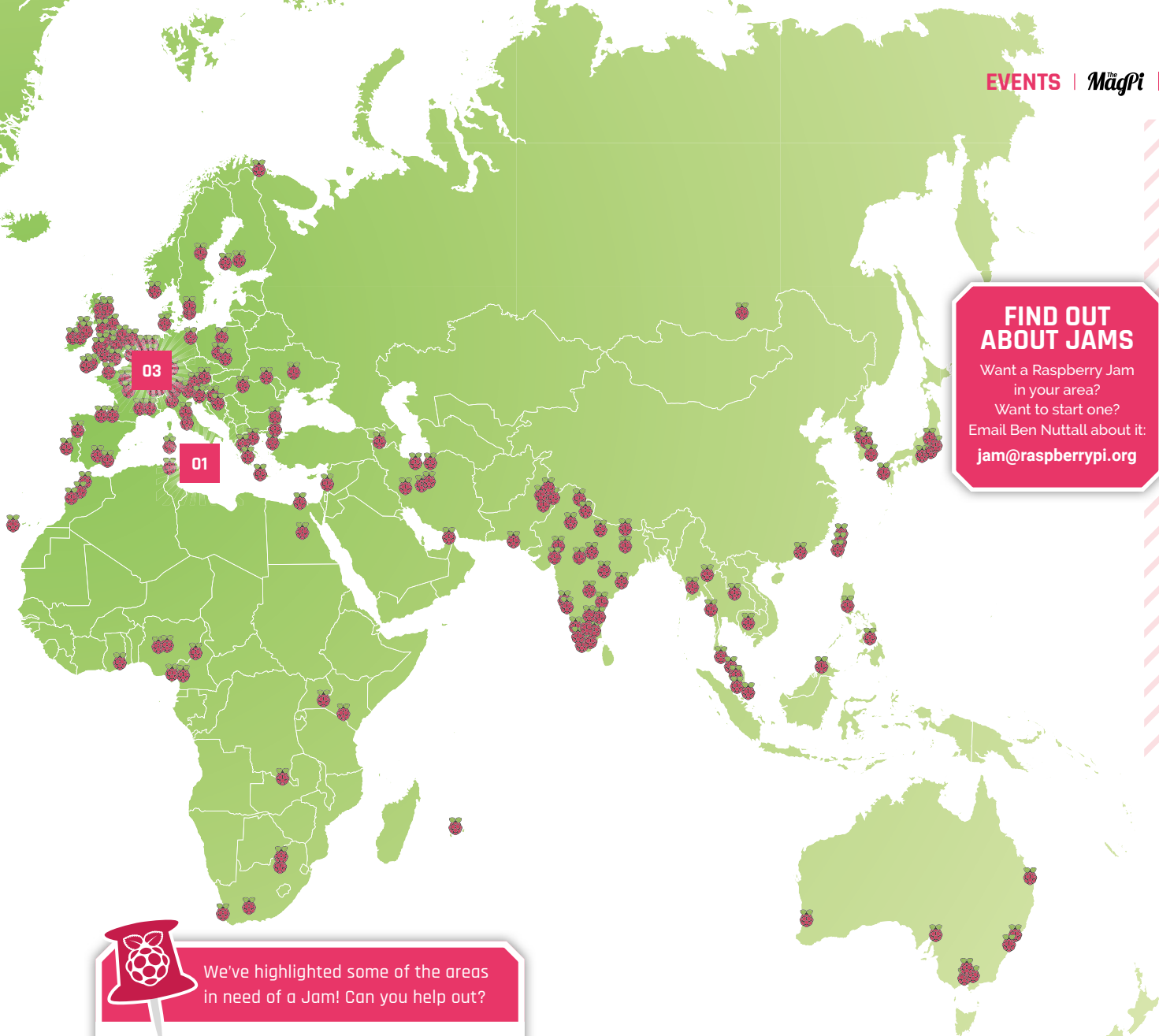

**FIND OUT ABOUT JAMS**  
 Want a Raspberry Jam in your area?  
 Want to start one?  
 Email Ben Nuttall about it:  
[jam@raspberrypi.org](mailto:jam@raspberrypi.org)

 We've highlighted some of the areas in need of a Jam! Can you help out?

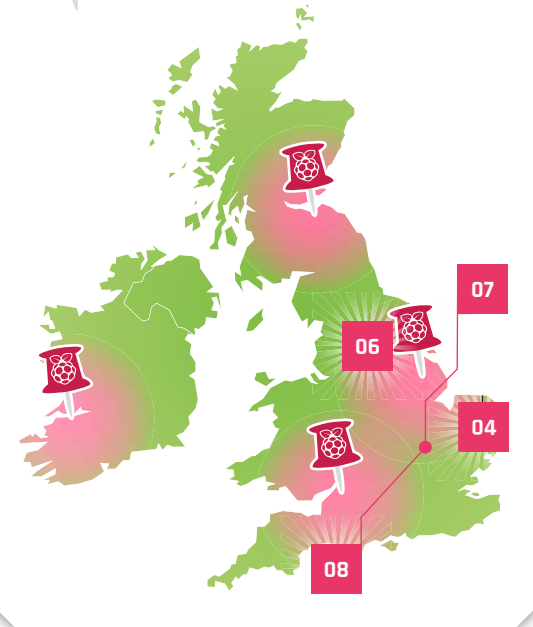

## Raspberry Jam advice: Fundraising

**“W**e hand out free raffle tickets while we shake the donation tin. Then we pull winning tickets from a box and they win a prize we've had donated, like a HAT or something.”

**Andrew Oakley – Cotswold Jam**

Every Raspberry Jam is entitled to apply for a Jam starter kit, which includes magazine issues, printed worksheets, stickers, flyers and more. Get the book here: [magpi.cc/2q9DHfQ](http://magpi.cc/2q9DHfQ)

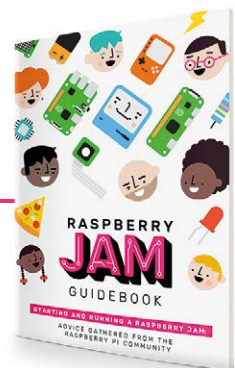

# Your Letters

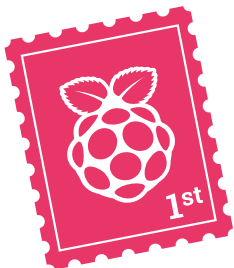

▼ The laptop build last issue uses a Pi Zero, but you can use a Pi 3 if you want to



## Three or Zero

I really loved the ‘build a laptop’ article from the October issue and was hoping to get started on it, or something similar. I just wanted to know if I’d be able to use a Raspberry Pi 3 instead of a Raspberry Pi Zero? I have a Pi 3 spare and as it’s a bit more powerful, I thought it might be better to use that!

**Paul** via email

The particular build in issue 74 of *The MagPi* uses a Pi Zero to make sure it’s as small as possible – however, there’s nothing stopping you using your Pi 3 and a different 3D-printed case! A lot of the parts, build tips, and software instructions will be similar, as you still need to have it powered by a battery and use wireless input devices. Check out the section on upcycling laptops as well, as that may be very relevant to you! [M](#)

## Highlighted

I’m a 70-year-old total newbie to Pi and its projects, many of which I find fascinating. I do have a question, though. In *The MagPi* issue 74 ‘Raspberry Pi on x86 laptops’, under the heading ‘Burn and boot’, there is what looks like a link ([magpi.cc/2joTqNm](http://magpi.cc/2joTqNm)).

I have tried many times to access this link for further info and am unable to? Please tell an old duffer what he needs to do.

**newbie70** from the forum

This one of the ‘shortlinks’ that we’ve posted in the magazine, usually to make typing in the (otherwise longer) links a bit easier. You just need to copy them into your browser. If you’re having problems, make sure to re-read the link and check to see if you’re using the correct letters.

If all else fails, all the links in *The MagPi* are clickable in the PDF version, so just load up the free PDF and click on it from in there. [M](#)

## Spooky projects

I enjoyed reading about the Halloween projects last issue! Will you be doing any highlights of reader projects at all this year? I have one that I might be able to send you if so, and I think there are a few others I could definitely point towards you...

**Derek** via email

We’d love to do a bit of a community Halloween project roundup this year, like we did last year! Issue 75 went to print a little too early for us to do it in time for Halloween, but check back in issue 76 and we’ll definitely try to find some of the most petrifying Pi projects that are out there.

Otherwise, you can always send them to the email address and other contact info above! [M](#)

## Contact us!

- ▶ Twitter [@TheMagPi](#)
- ▶ Facebook [magpi.cc/facebook](http://magpi.cc/facebook)
- ▶ Email [magpi@raspberrypi.org](mailto:magpi@raspberrypi.org)
- ▶ Online [raspberrypi.org/forums](http://raspberrypi.org/forums)



▶ Send us your scary builds



**Birthday parties**

I had a lot of fun at the birthday Jams and Raspberry Fields last year. Is there any info yet on if you'll be doing anything like that again?

**Stephanie** on Twitter

Good timing – we've got info about Big Birthday Weekend 2019 in the This Month in Raspberry Pi section. It's a similar deal to this year: Jams

▶ Raspberry Pi is bringing back the Big Birthday Weekend again next year

around the world will celebrate the Raspberry Pi's birthday in coordinated Jams. Hopefully none of them will be snowed off next year!

As for Fields, we don't have any news about that yet. We feel like the events team is still recovering from the one in the summer! We'll let you know as soon as we can if there are plans for another one! **M**



# HiFiBerry

## High Performance Audio For Raspberry Pi

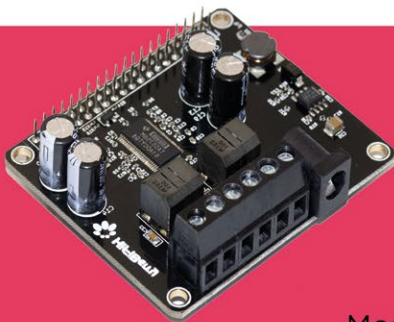

### HiFiBerry AMP2

integrated Digital-to-Analog Converter  
60W power, up to 8Ohm speakers  
supports sample rates from 44.1 - 192khz

HAT modules  
no soldering  
needed

### HiFiBerry DAC+

Most sold Digital-to-Analog converter  
192khz/24bit offers high end sound quality  
also available as DAC+ light, DAC+ pro and DAC+ DSP

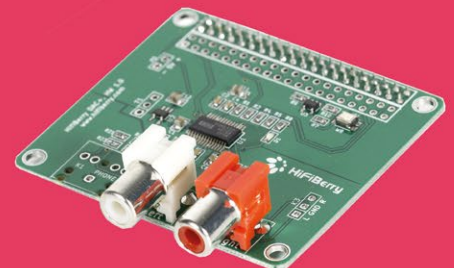

### What to built with HiFiBerry soundcards?

Small but versatile players with network based sources and streaming solutions, multiroom setups, upcycling of vintage speakers, DSP applications and many more.

visit [hifiberry.com](http://hifiberry.com) for complete product range, guides and inspirations

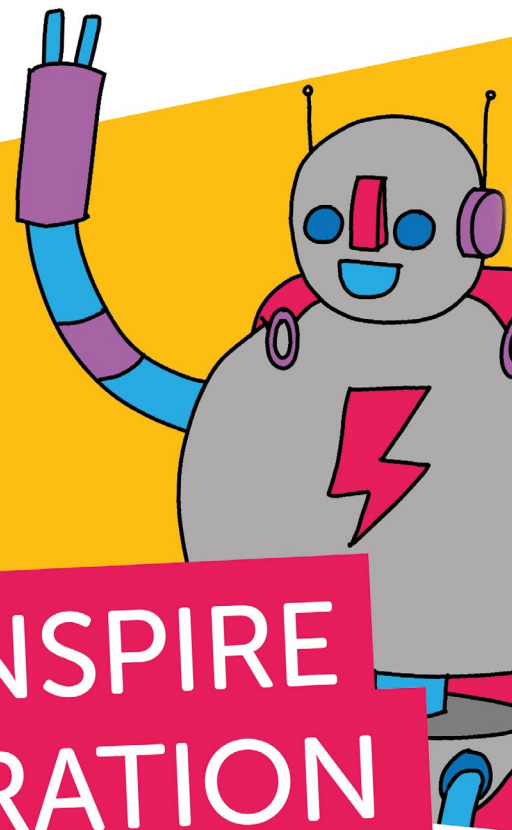
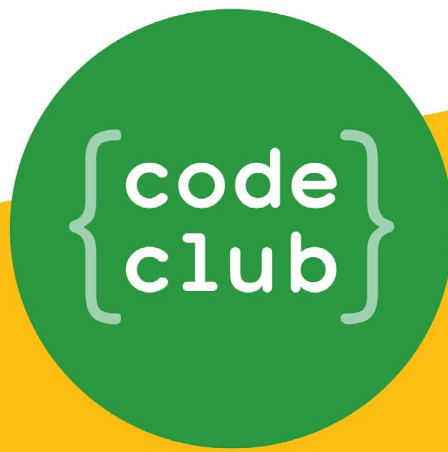
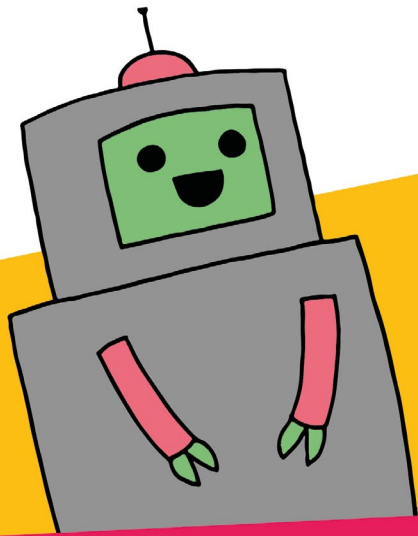

# CAN YOU HELP INSPIRE THE NEXT GENERATION OF CODERS?



Code Club is a network of volunteers and educators who run free coding clubs for young people aged 9-13.

We're always looking for people with coding skills to volunteer to run a club at their local school, library, or community centre.

You can team up with friends or colleagues, you will be supported by someone from the venue, and we provide all the materials you'll need to help children get excited about digital making.

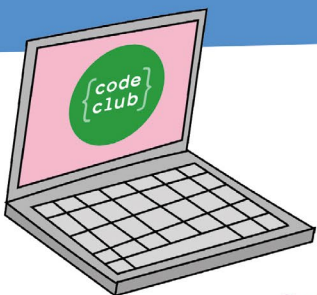

To find out more, join us at  
[www.codeclubworld.org](http://www.codeclubworld.org)





**WIN**

# One of Two Picade retro gaming consoles!

▣ The ultimate desktop retro arcade machine! Picade is a Raspberry Pi-powered mini arcade that you build yourself, with authentic arcade controls ▣

We loved the new Picade in issue 74 of *The MagPi* ([magpi.cc/74](http://magpi.cc/74)). With an authentic arcade controls and an eighties look straight from your nostalgia, it's the perfect retro gaming device for your home.

**Pimoroni** has given us a Picade and Picade Console to give away, so enter today for your chance to win one!

Enter **now** at: [magpi.cc/win](http://magpi.cc/win)



In association with

**PIMORONI**

Learn more: [magpi.cc/sAWJzh](http://magpi.cc/sAWJzh)

## Terms & Conditions

Competition opens on **24 October 2018** and closes on **29 November 2018**. Prize is offered to participants worldwide aged 13 or over, except employees of the Raspberry Pi Foundation, the prize supplier, their families or friends. Winners will be notified by email no more than 30 days after the competition closes. By entering the competition, the winner consents to any publicity generated from the competition, in print and online. Participants agree to receive occasional newsletters from The MagPi magazine. We don't like spam: participants' details will remain strictly confidential and won't be shared with third parties. Prizes are non-negotiable and no cash alternative will be offered. Winners will be contacted by email to arrange delivery. Any winners who have not responded 60 days after the initial email is sent will have their prize revoked. This promotion is in no way sponsored, endorsed or administered by, or associated with, Instagram or Facebook.



CoderDojo

# Can you encourage young people to become digital creators?



CoderDojo is a global network of free, volunteer-led, project-based programming clubs for young people aged 7-17. Here they can learn to code, build a website, create an app or a game, and explore technology in an informal, creative, and social environment.



In order to run locally we need volunteers like you with a wide range of skills. You don't have to be a coder to mentor. Dojos benefit from a mix of mentors providing support and encouragement to CoderDojo attendees.



Dojo champions, who manage each club, will be able to discuss how you can best support attendees, and we'll provide you with any resources and advice you might need.



**Join us at [coderdojo.com/volunteer](https://coderdojo.com/volunteer)**



# Stay Tuned

THE MAGPI #76 ON SALE 29 NOV

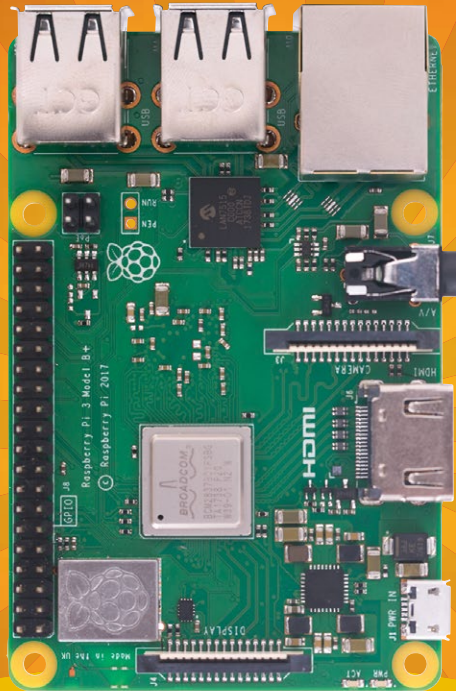

**Plus!**  
Smart  
Lights  
Control home  
lighting with  
Raspberry Pi

## THE ULTIMATE RASPBERRY PI HERO GUIDE

### Also

Build your own video display unit

Code Pac-Man in Pygame Zero

Speed up AI with Google's  
Edge TPU

Top 10 Christmas kits

And much, much more

DON'T MISS OUT!

[magpi.cc/subscribe](http://magpi.cc/subscribe)

**TWITTER** @TheMagPi

**FACEBOOK** fb.com/MagPiMagazine

**EMAIL** [magpi@raspberrypi.org](mailto:magpi@raspberrypi.org)

### EDITORIAL

#### Editor

Lucy Hattersley  
[lucy@raspberrypi.org](mailto:lucy@raspberrypi.org)

#### Features Editor

Rob Zwetsloot  
[rob.zwetsloot@raspberrypi.org](mailto:rob.zwetsloot@raspberrypi.org)

#### Sub Editors

Phil King and Nicola King

### DESIGN

[criticalmedia.co.uk](http://criticalmedia.co.uk)

#### Head of Design

Dougal Matthews

#### Designers

Mike Kay, Lee Allen, Harriet Knight

#### Illustrator

Sam Alder

### CONTRIBUTORS

Wes Archer, Brian Beuken,  
Mike Cook, Philip Colligan,  
David Crookes, PJ Evans, Rosie  
Hattersley, Nicola King, Amy  
O'Meara, Carrie Anne Philbin, Eben  
Upton, Liz Upton, Mark Vanstone

### PUBLISHING

#### Publishing Director

Russell Barnes  
[russell@raspberrypi.org](mailto:russell@raspberrypi.org)  
+44 (0)7904 766523

#### Director of Communications

Liz Upton

#### CEO

Eben Upton

### DISTRIBUTION

Seymour Distribution Ltd  
2 East Poultry Ave,  
London EC1A 9PT  
+44 (0)207 429 4000

### SUBSCRIPTIONS

Raspberry Pi Press  
Mann Enterprises, Unit E,  
Brocks Business Centre, Haverhill,  
CB9 8QP

#### To subscribe

[magpi.cc/subscribe](http://magpi.cc/subscribe)

#### To get help:

[magpi.cc/subshelp](http://magpi.cc/subshelp)



This magazine is printed on paper sourced from sustainable forests and the printer operates an environmental management system which has been assessed as conforming to ISO 14001.

The MagPi magazine is published by Raspberry Pi (Trading) Ltd., 30 Station Road, Cambridge, CB1 2JH. The publisher, editor, and contributors accept no responsibility in respect of any omissions or errors relating to goods, products, or services referred to or advertised in the magazine. Except where otherwise noted, content in this magazine is licensed under a Creative Commons Attribution-NonCommercial-ShareAlike 3.0 Unported (CC BY-NC-SA 3.0). ISSN: 2051-9982.



Raspberry Pi Press  
Attribution-NonCommercial-ShareAlike 3.0 Unported (CC BY-NC-SA 3.0).  
ISSN: 2051-9982.



# Making magazines

Eben Upton on building physical products

Once, I thought running a hardware company would be all about making hardware. Turns out, it's actually about learning new things.

When we started back in 2006, I was an embedded software engineer: I knew how to crank out high-performance C and assembler for mobile phones, games consoles, and microcontrollers, but absolutely nothing about how to design chips or PCBs, still less how to build millions of units of a physical product and get them to customers all over the world.

Still, it's amazing what you can pick up if you hang out with bright people.

## Once upon a time

Around the time I was building the first Raspberry Pi prototype (on Veroboard!) in 2006, I joined Broadcom as a software engineer in the video and graphics team, and got my first taste of hardware design. Although I was supposed to stick to writing firmware, every software engineer had access to the Verilog source code for the chip that we were working on. Nobody in their right mind would let me write a module from scratch, but if I could find a bug, and get my fix signed off by the real hardware engineer in the next cubicle (future Raspberry Pi COO James Adams), my code might make it into the chip.

A couple of years later, we started work on the first real Raspberry Pi

design. There's a vast difference between soldering down some PDIP chips on a piece of Veroboard, with signals running at a few tens of megahertz, and escaping high-speed signals like HDMI from a fine-pitch BGA on a six-layer PCB. But I got to watch over my co-founder Pete Lomas's shoulder while he laid

do this, and equally insistent that we should recruit Russell Barnes as editor. After five digital-only issues, the magazine made a triumphant return to print in August 2015, and has never looked back. Russell has surrounded himself with an amazing team, including Lucy and Rob here at *The MagPi*, and Ben and Andrew

“ I spend a wholly inappropriate amount of time thinking about our publishing business ”

out what would become the classic Raspberry Pi Model B. And six months later, I got to watch Mike Buffham (future Raspberry Pi Director of Product Management) figure out how to build Pete's design in volume at Sony.

I'll never be able to write Verilog like James, lay out a PCB like Pete, or juggle a supply chain like Mike. But hanging out with them taught me more about hardware, and about business, than any course or textbook could.

## Going to print

Which brings me to publishing. At the start of 2015, we had the opportunity to take up the reins of *The MagPi* from Ash, Will, Ian, and Aaron, who had been running it since 2012. Liz was quite insistent that we should

at HackSpace, and together they've done amazing things.

I spend a wholly inappropriate amount of time thinking about our publishing business. In part, that's because it's further from my comfort zone than anything else we do: there's just so much for me to learn here. But it's also because even I can see the scale of the opportunity ahead of us. I think you're going to love what the team has planned over the next couple of years, but for now let's raise a glass to the first 75 issues of *The MagPi*, and to the next 75. 🍷

## AUTHOR Eben Upton

Eben is the creator of Raspberry Pi and a co-founder of the Raspberry Pi Foundation. He has extraordinary travel booking skills.

[magpi.cc/eben](http://magpi.cc/eben)



THE *Official*

# RASPBERRY PI BEGINNER'S BOOK

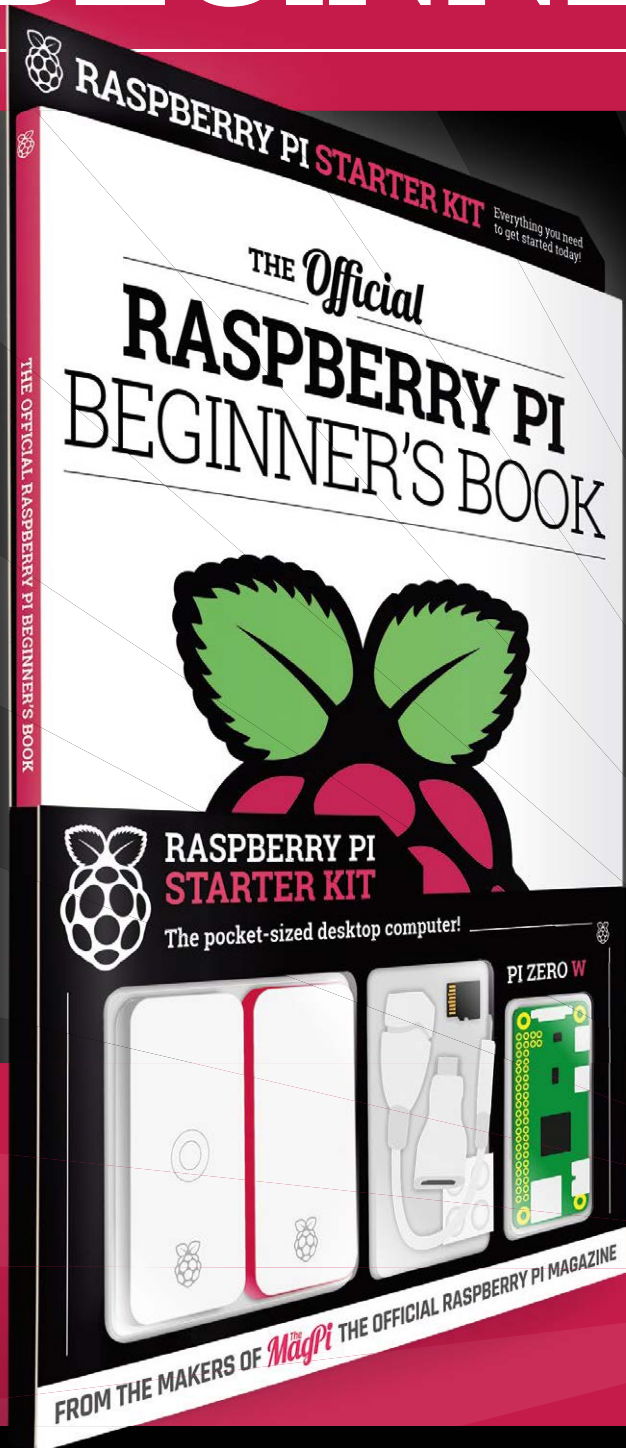

LEARN  
COMPUTING  
THE EASY WAY!

## Includes

- Pi Zero W computer
- Official case with three covers
- USB and HDMI adapters
- 8GB microSD card
- 116-page beginner's book

Available  
now

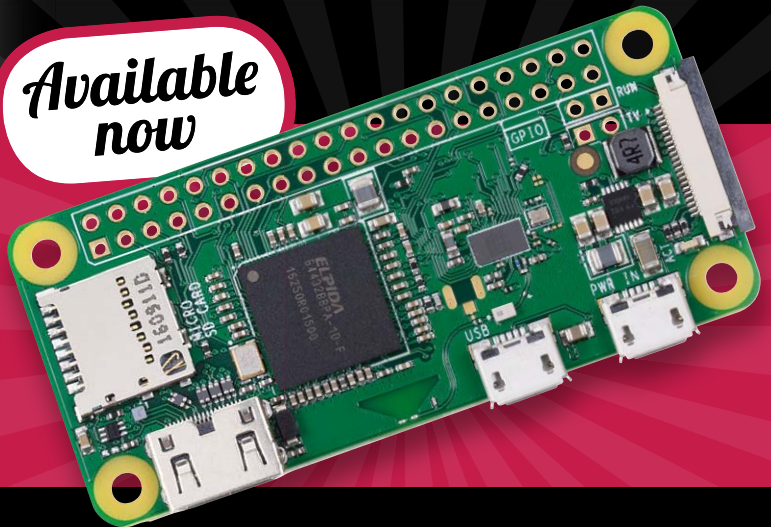

Buy online: [magpi.cc/store](https://magpi.cc/store)

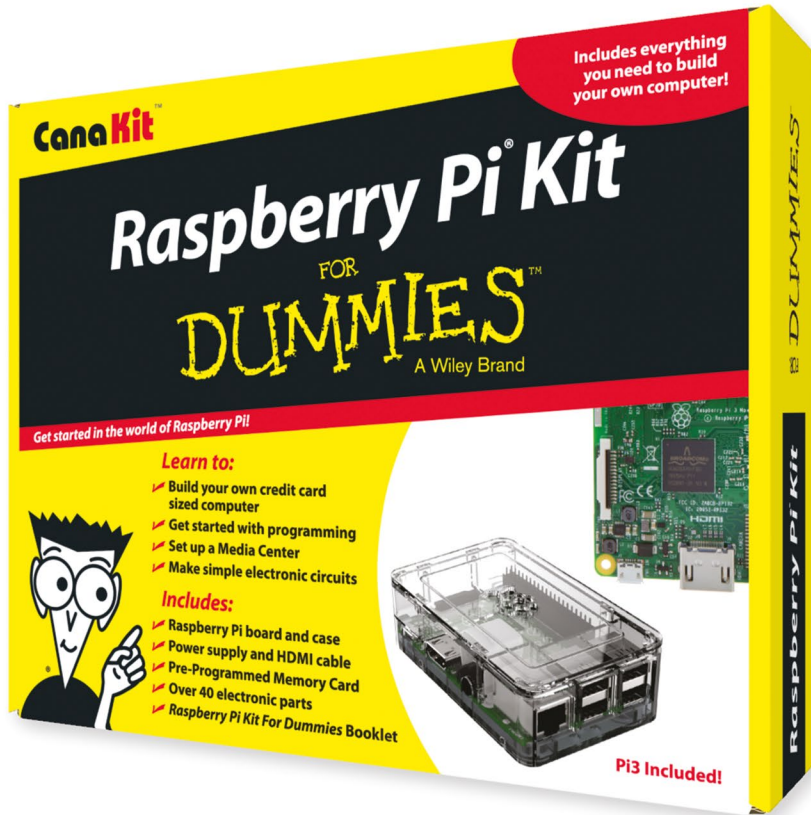

**Kit Includes:**

- ✓ **Raspberry Pi For Dummies Booklet**
- ✓ **Raspberry Pi 3 Board**
- ✓ **Memory Card**
- ✓ **Plastic Case**
- ✓ **2.5A Power Supply**
- ✓ **HDMI Cable**
- ✓ **Resistors**
- ✓ **LEDs**
- ✓ **Push Button Switches**
- ✓ **Prototyping Breadboard**
- ✓ **Jumper Wires**
- ✓ **Heat Sinks**

FOR  
**DUMMIES**<sup>®</sup>  
A Wiley Brand

Available for worldwide shipping at:

**WWW.CANAKIT.COM**

Available in Europe  
through RS Components



**\$89<sup>.99</sup>**  
US DOLLARS

**£69<sup>.99</sup>**  
EXCLUDING VAT

Raspberry Pi is a registered trademark of the Raspberry Pi Foundation. For Dummies and the Dummies Man logo are trademarks or registered trademarks of John Wiley & Sons, Inc. Used under license. RS logo is a registered trademark of RS Components Ltd. CanaKit is a registered trademark of Cana Kit Corporation.